

Freestanding Fire Pit

ecosmart⁺
Fire

Stix Series



ecosmartfire.com

Stix Series Design features



Environmentally-Friendly

Bioethanol fireplaces use an environmentally-friendly, renewable energy source that burns clean and delivers strong warming heat. You and your guests will enjoy the ambiance and tranquility of a real fire, without the hassles of burning real wood - no more embers, ash, and soot to clean up.

Ground Fixing Brackets

Models come with fixing brackets for permanently locating into a fixed position.

Available in Two Sizes

The Stix Series is available in two sizes – Stix (small) and Stix 8 (large) – and are striking either standalone or together.



Stix 8



Stix

1. Versatile & Incredibly Durable

EcoSmart portable fireplaces are versatile, incredibly durable, and are constructed of weather resistant materials. These appliances are designed to look great for years, and will perform admirably through all four seasons.

*If located in coastal areas or near swimming pools, Stix needs to be washed down regularly to remove salt/pool water to prevent rust.

Quick & Easy Installation

With no installation or building works required, simply unpack, put into position, and off you go.

2. Colours

Stix 8 is available in Black. Stix is available in Black or Stainless Steel.

Burner Colours

Stix 8 is available with a Black. Stix is available with a Black or Stainless Steel Burner.

Global Compliance

These models comply with existing standards in the USA and Australia. O-TL listed to UL 1370 and ACCC Safety Mandate compliant.

Included Accessories



Jerry Can with Safety Spout & e-NRG bottle adaptor



Lighting Rod & Lighter



AB8 Efficiency Ring (Stix 8 only)



Jerry Can Spout Extension

Optional Accessories



Outdoor Cover

Disclaimer. All product specifications and data are subject to change without notice and believed to be correct at the time of publication. MAD Design Group (MDG), its affiliates, agents, and employees, and all persons acting on its or their behalf (collectively, "MAD Design Group"), disclaim any and all liability for any errors, inaccuracies or incompleteness contained herein or in any other disclosure relating to any product. MDG disclaims any and all liability arising out of the use or application of any product described herein or of any information provided herein to the maximum extent permitted by law. The product specifications do not expand or otherwise modify MDG's terms and conditions of purchase, including but not limited to the warranty expressed therein, which apply to these products. No license, express or implied, by estoppel or otherwise, to any intellectual property rights is granted by this document or by any conduct of MDG. Customers using or selling MDG products not expressly indicated for use in such applications do so entirely at their own risk and agree to fully indemnify MDG for any damages arising or resulting from such use or sale. Please contact authorised personnel from MDG to obtain written terms and conditions regarding products designed for such applications. Images are indicative only.



Stix 8 Specifications

The stylish, award-winning and visually appealing Stix just got bigger! Introducing Stix 8.

Ventilation and Efficiency*

Model Dimensions L x W x H mm/in	Compatible Burner	Fuel Capacity	Heats on Average (Indoors)	Thermal Output Net (MAX per burner)	Approx. Burn Time	Minimum Room Size
770 x 770 x 1085 30.3 x 30.3 x 42.7	AB8	8 L [2.1 Gals]	Over 60 m ² [645 ft ²]	21.56 MJ/h 20,433 BTU/h, 5.99 kW	7 - 9 hours	116 m ³ [4,096 ft ³]
			Over 30 m ² [322.9 ft ²]	13.9 MJ/h 12,860 BTU/h, 3.77 kW	9 - 11 hours	

With Efficiency Ring** (EN Compliant)

Application	Indoor & Outdoor
Surround Colour	 Black ESF.O.STX8.BL
Burner Colour	 Black
Materials	Grade 202 Stainless Steel with Black Powder-Coating, Grade 304 Stainless Steel Burner with Black Ceramic Coating
Approx. Weight	30.9kg [68.1lbs] Weight includes burner.
Fuel Type	e-NRG Bioethanol / e-NRG.com

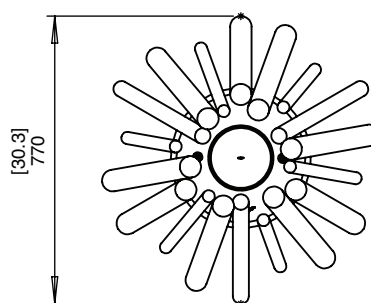
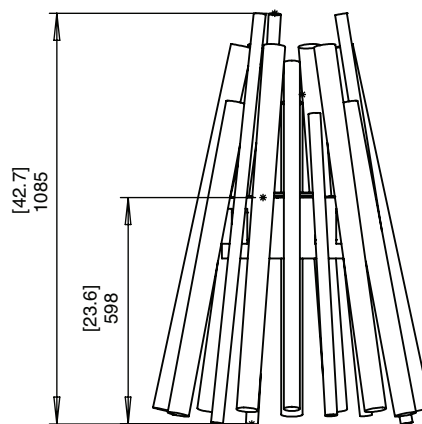

*These values are indicative only and may vary depending on the model purchased, installation, and the seasonal resource used to manufacture e-NRG.

This model comes with fixing brackets for permanently locating into a fixed position.

This model complies with existing standards in the USA and Australia. O-TL listed to UL 1370 and ACCC Safety Mandate compliant.

FOR MORE INFORMATION PLEASE REFERENCE THE CLEARANCE & INSTALLATION MANUAL













Disclaimer. All product specifications and data are subject to change without notice and believed to be correct at the time of publication. MAD Design Group (MDG), its affiliates, agents, and employees, and all persons acting on its or their behalf (collectively, "MAD Design Group"), disclaim any and all liability for any errors, inaccuracies or incompleteness contained herein or in any other disclosure relating to any product. MDG disclaims any and all liability arising out of the use or application of any product described herein or of any information provided herein to the maximum extent permitted by law. The product specifications do not expand or otherwise modify MDG's terms and conditions of purchase, including but not limited to the warranty expressed therein, which apply to these products. No license, express or implied, by estoppel or otherwise, to any intellectual property rights is granted by this document or by any conduct of MDG. Customers using or selling MDG products not expressly indicated for use in such applications do so entirely at their own risk and agree to fully indemnify MDG for any damages arising or resulting from such use or sale. Please contact authorised personnel from MDG to obtain written terms and conditions regarding products designed for such applications. Images are indicative only.

Stix Specifications

Stix is an award winning fireplace with a geometrical look that evokes the mood and magnetism of a traditional campfire.

Ventilation and Efficiency*

Model Dimensions L x W x H mm/in	Compatible Burner	Fuel Capacity	Heats on Average (Indoors)	Thermal Output Net (MAX per burner)	Approx. Burn Time	Minimum Room Size
557 x 556 x 780 21.9 x 21.9 x 30.7	AB3	2.5 L [0.7 Gals]	Over 20 m ² [215 ft ²]	6.14 MJ/h 5,800 BTU/h 1.7 kW	8 - 11 hours	40 m ³ [1,413 ft ³]

Awards	2011 DesignEx Best New Product (AUS) 2011 IIDA/HD Award for Excellence (USA)		
Application	Indoor & Outdoor		
Surround Colours	<table border="0"> <tr> <td> Stainless Steel ESF.O.STX.SS</td> <td> Black ESF.O.STX.BL</td> </tr> </table>	 Stainless Steel ESF.O.STX.SS	 Black ESF.O.STX.BL
 Stainless Steel ESF.O.STX.SS	 Black ESF.O.STX.BL		
Burner Colours	<table border="0"> <tr> <td> Stainless Steel</td> <td> Black</td> </tr> </table>	 Stainless Steel	 Black
 Stainless Steel	 Black		
Materials	Brushed Grade 304 Stainless Steel, Grade 202 Stainless Steel with Black Powder-Coating (Stix Black), Grade 304 Stainless Steel Burner, with optional Black Ceramic Coating		
Approx. Weight	14kg [30.8lbs] Weight includes burner.		
Fuel Type	e-NRG Bioethanol / e-NRG.com		

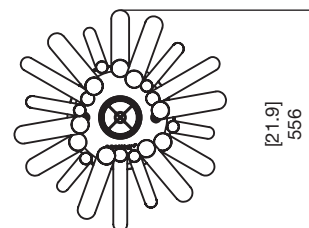
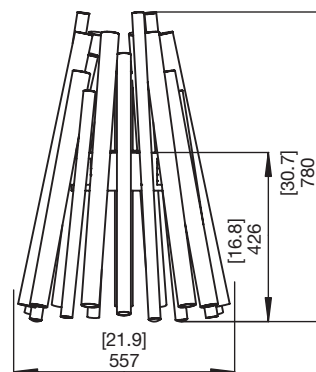

*These values are indicative only and may vary depending on the model purchased, installation, and the seasonal resource used to manufacture e-NRG.
This model comes with fixing brackets for permanently locating into a fixed position.
This model complies with existing standards in the USA and Australia. O-TL listed to UL 1370 and ACCC Safety Mandate compliant.

FOR MORE INFORMATION PLEASE REFERENCE THE CLEARANCE & INSTALLATION MANUAL

Disclaimer. All product specifications and data are subject to change without notice and believed to be correct at the time of publication. MAD Design Group (MDG), its affiliates, agents, and employees, and all persons acting on its or their behalf (collectively, "MAD Design Group"), disclaim any and all liability for any errors, inaccuracies or incompleteness contained herein or in any other disclosure relating to any product. MDG disclaims any and all liability arising out of the use or application of any product described herein or of any information provided herein to the maximum extent permitted by law. The product specifications do not expand or otherwise modify MDG's terms and conditions of purchase, including but not limited to the warranty expressed therein, which apply to these products. No license, express or implied, by estoppel or otherwise, to any intellectual property rights is granted by this document or by any conduct of MDG. Customers using or selling MDG products not expressly indicated for use in such applications do so entirely at their own risk and agree to fully indemnify MDG for any damages arising or resulting from such use or sale. Please contact authorised personnel from MDG to obtain written terms and conditions regarding products designed for such applications. Images are indicative only.