

WILD FLAME

DUTCH MANUFACTURER

SCHEME OF AUTOMATIC BIOFIREPLACE SMART FIRE A7 2000 MM

FRONT VIEW

SIDE VIEW

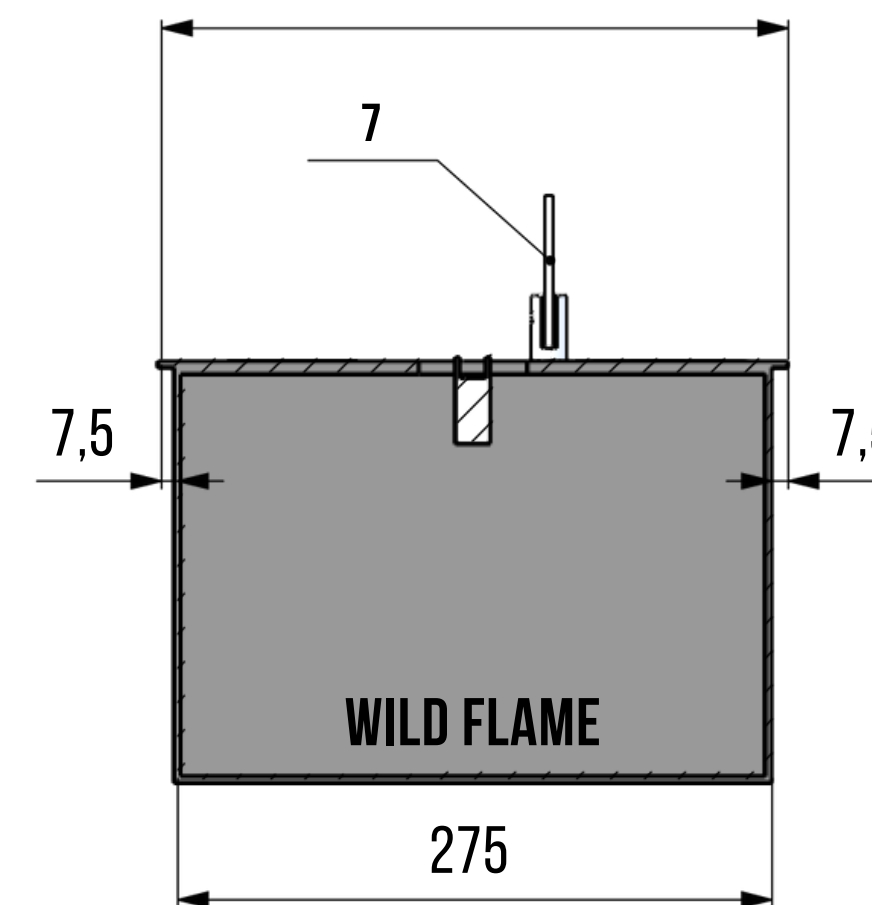
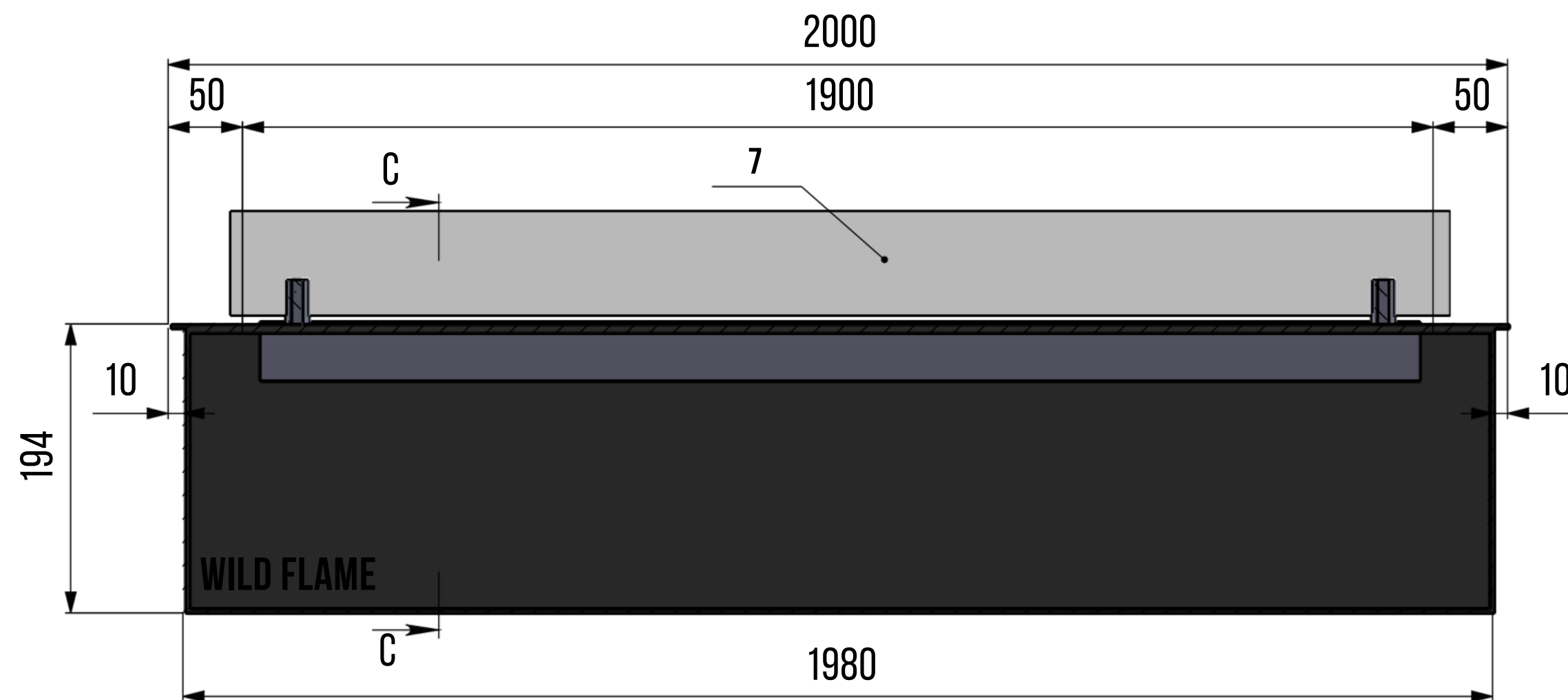

TOP VIEW

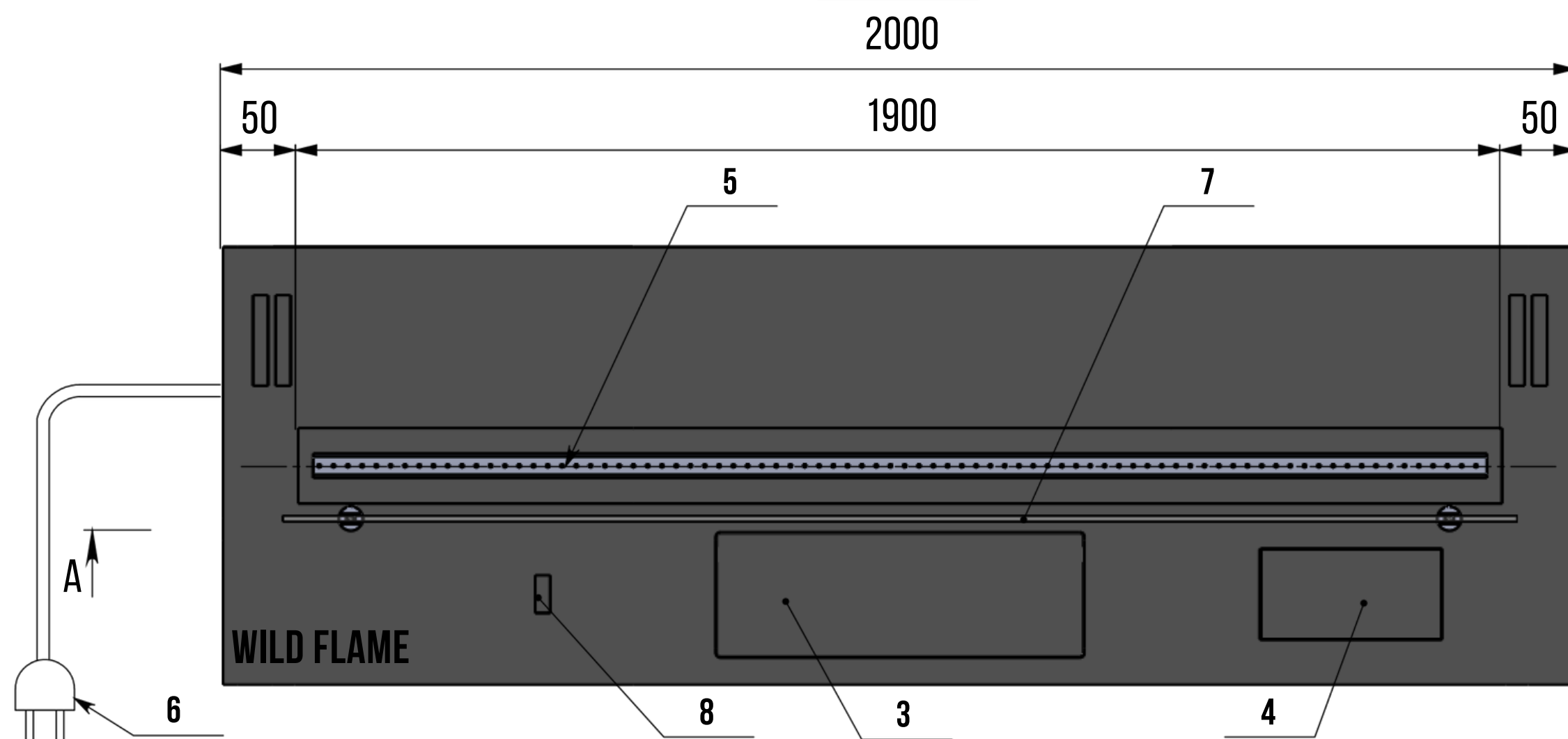

NO:	NAMES
1	FRONT PANEL OF AUTOMATIC BIOFIREPLACE
2	DOUBLE - WALL HULL
3	CONTROL PANEL COVER AND REFUELING
4	WIRELESS CHARGING SURFACE
5	FIRE LINE
6	POWER CABLE (220V)
7	TEMPERED SAFETY GLASS
8	SENSOR FOR OPENING THE COVER OF THE CONTROL PANEL AND REFUELING

COLOUR: ACCORDING TO RAL SCALE _____
WEIGHT: 60 KG.

SCHEME OF SMART FIRE A7
2000 X 290 X 194 MM
WWW.WILDFLAME.NL

WILD FLAME

DUTCH MANUFACTURER

SCHEME OF NICHE FOR AN AUTOMATIC BIOFIREPLACE SMART FIRE A7 2000 MM (OVERLAP)

FRONT VIEW

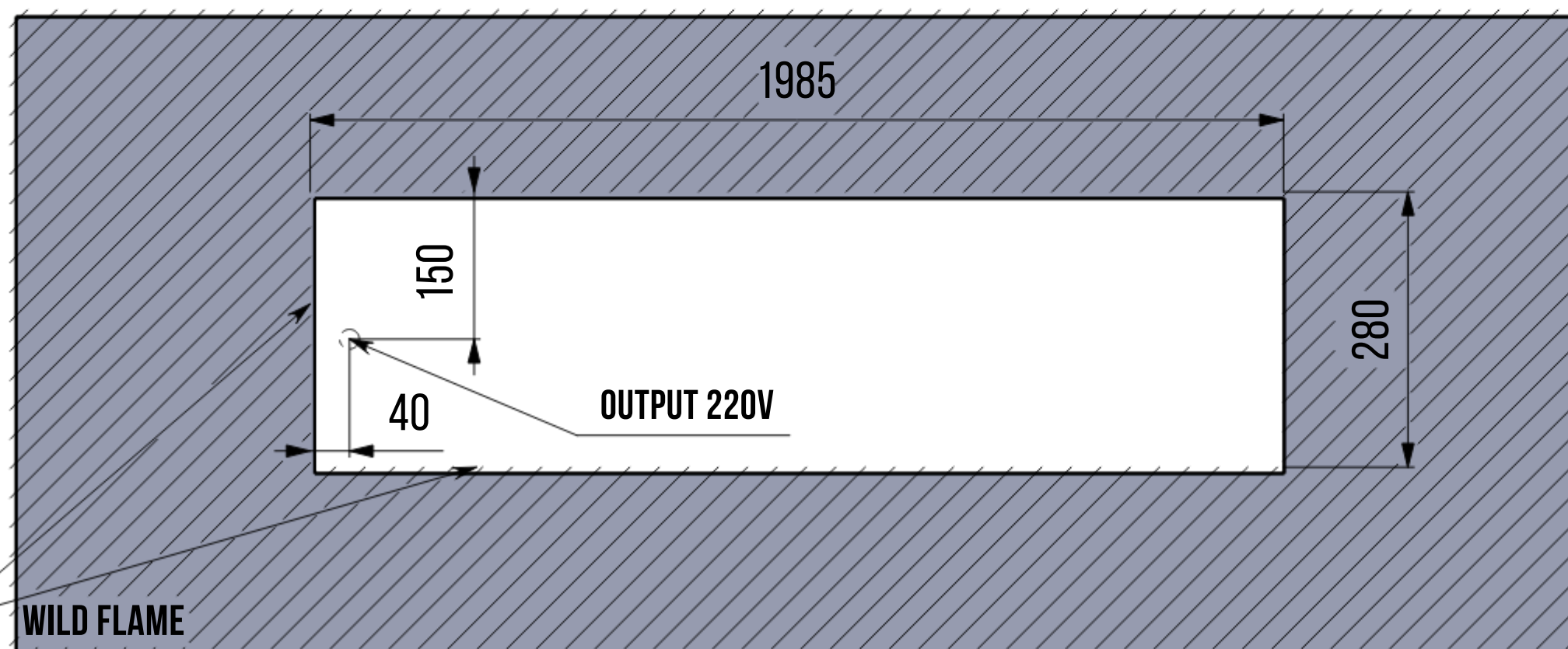

NICHE DIMENSIONS FOR EMBEDDING THE FUEL BLOCK:

NICHE LENGTH - 1985 MM

NICHE WIDTH - 280 MM

NICHE DEPTH - 220 MM



TOP VIEW

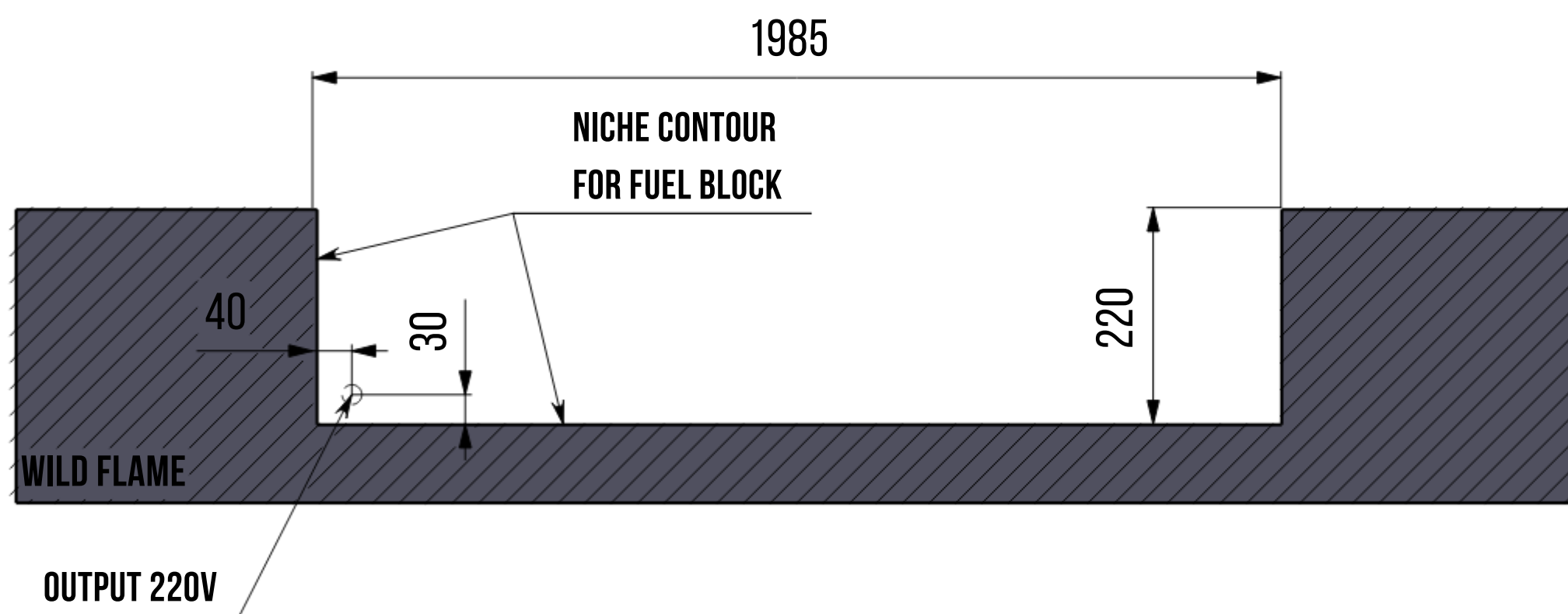

SIDE VIEW

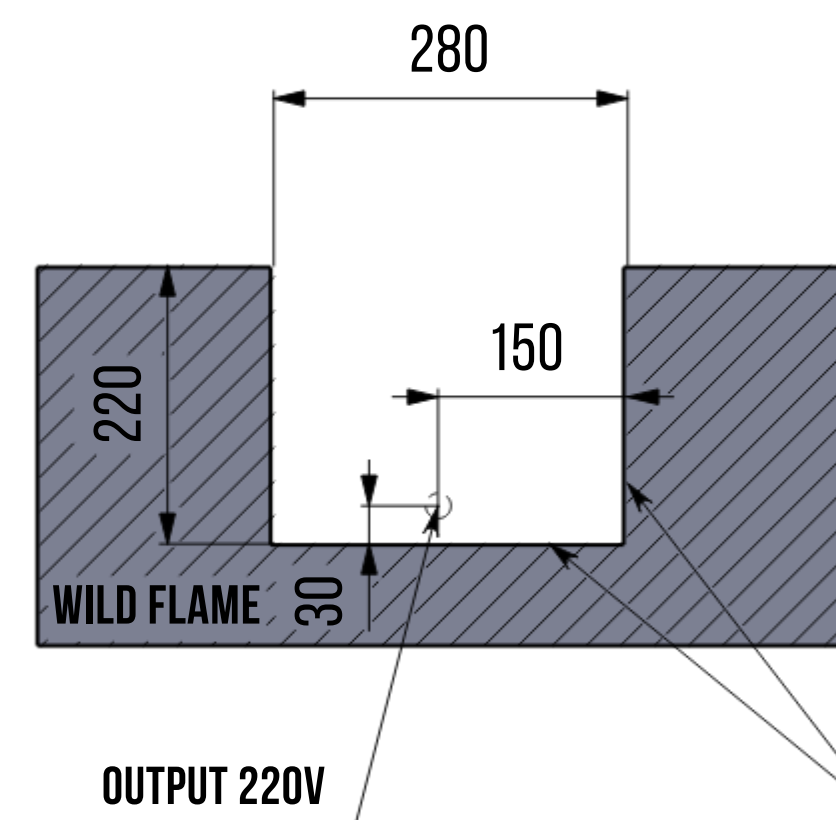

WILD FLAME

DUTCH MANUFACTURER

SCHEME OF NICHE FOR AN AUTOMATIC BIOFIREPLACE SMART FIRE A7 2000 MM (FLUSH - MOUNTED)

FRONT VIEW

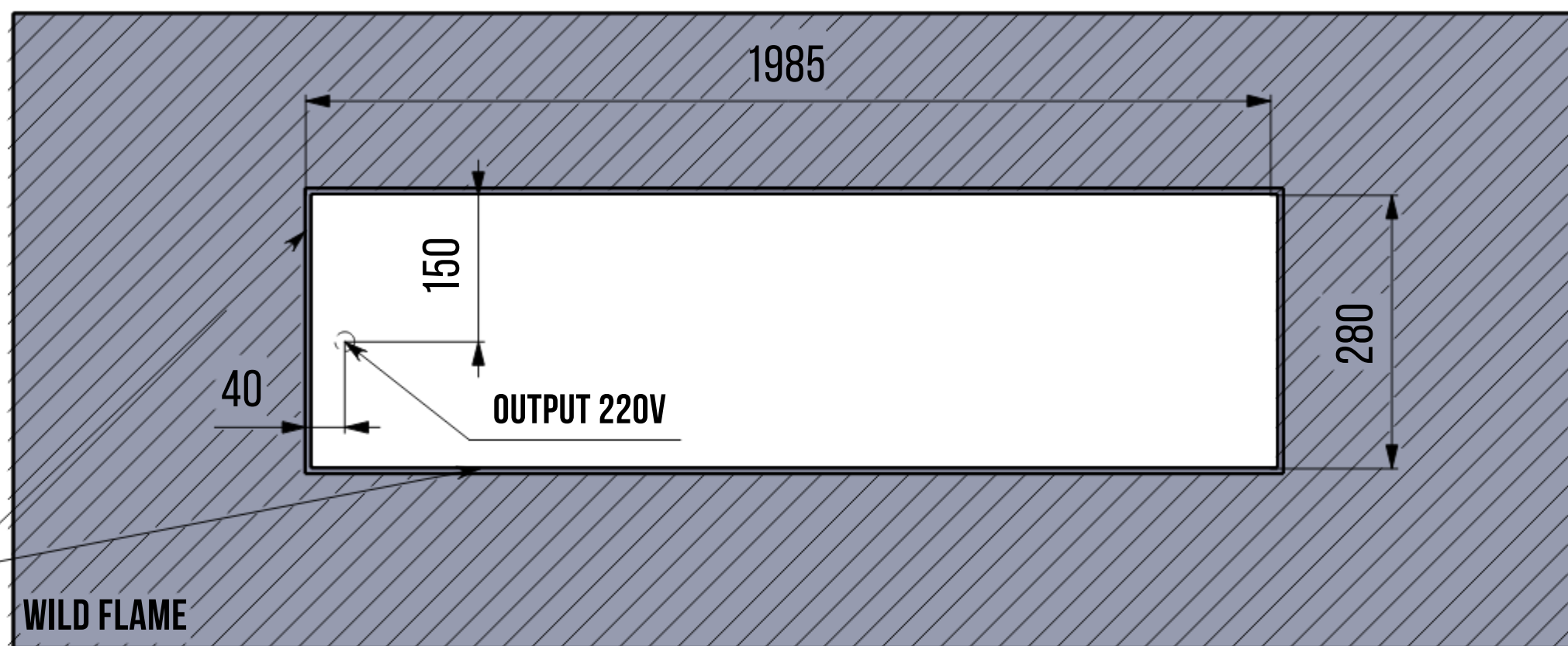

NICHE DIMENSIONS FOR EMBEDDING THE BIOFIREPLACE:

NICHE LENGTH - 1985 MM

NICHE WIDTH - 280 MM

NICHE DEPTH - 220 MM

DIMENSIONS OF THE SEAT FOR THE FRONT PANEL OF THE BIOFIREPLACE:

NICHE LENGTH - 2002 MM

NICHE WIDTH - 292 MM

NICHE DEPTH - 3 MM



NICHE CONTOUR FOR FUEL BLOCK

WILD FLAME

TOP VIEW

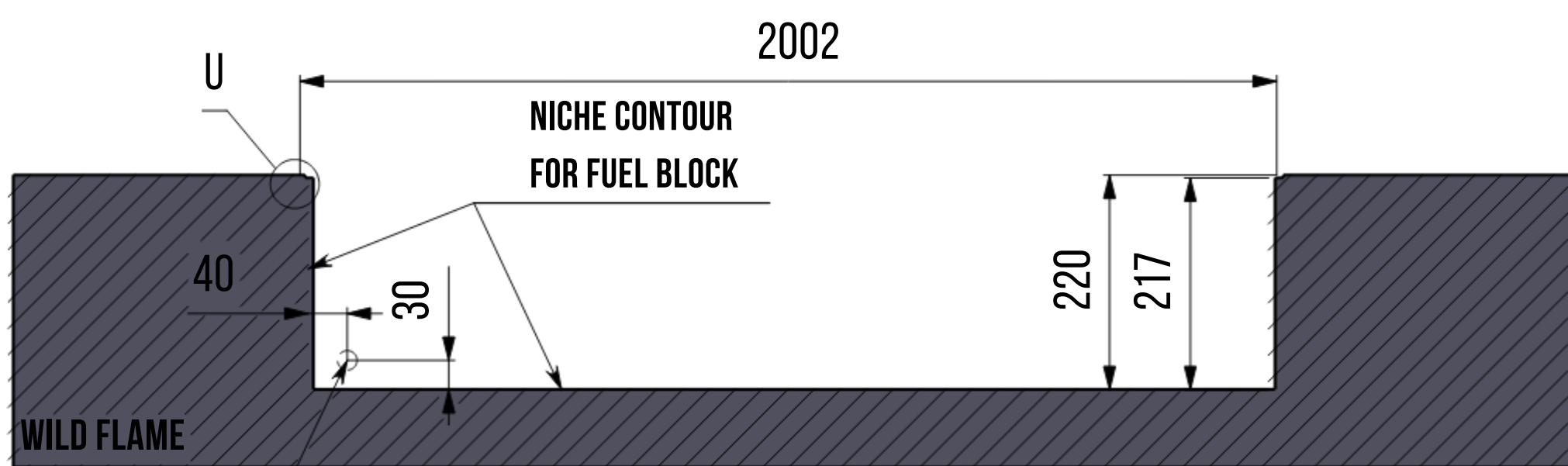
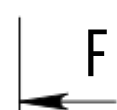

OUTPUT 220V

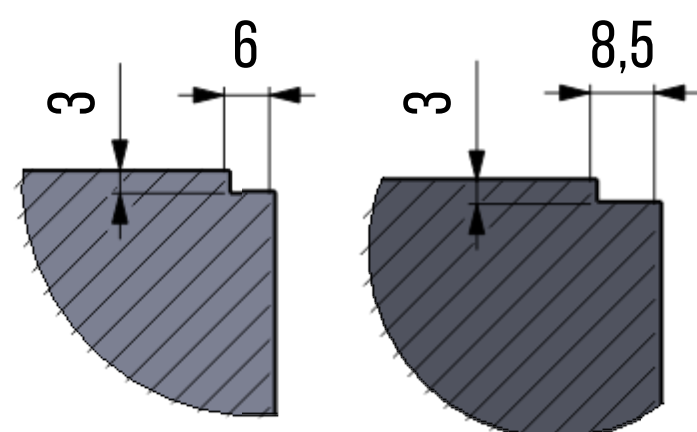

SIDE VIEW

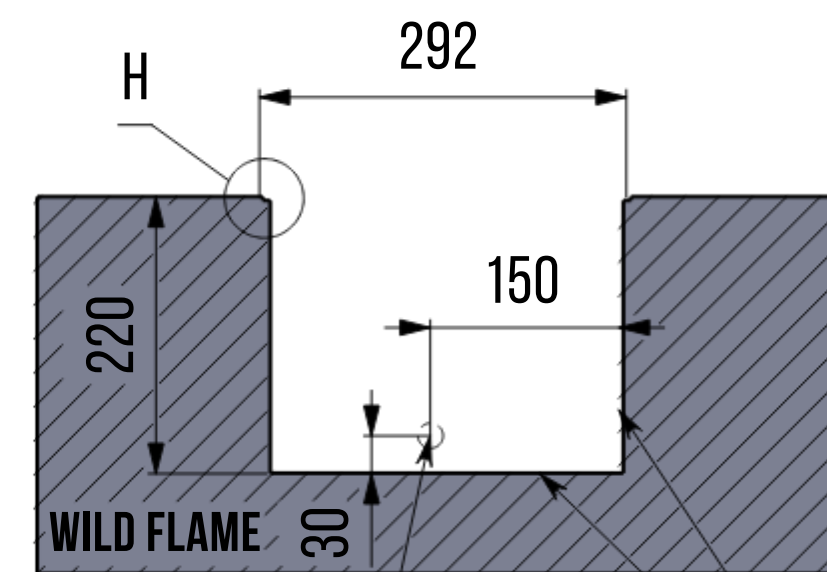

OUTPUT 220V

NICHE CONTOUR FOR FUEL BLOCK

WILD FLAME

DUTCH MANUFACTURER

SCHEME OF INSTALLATION OF AN AUTOMATIC BIOFIREPLACE SMART FIRE A7 2000 MM IN A NICHE (OVERLAP)

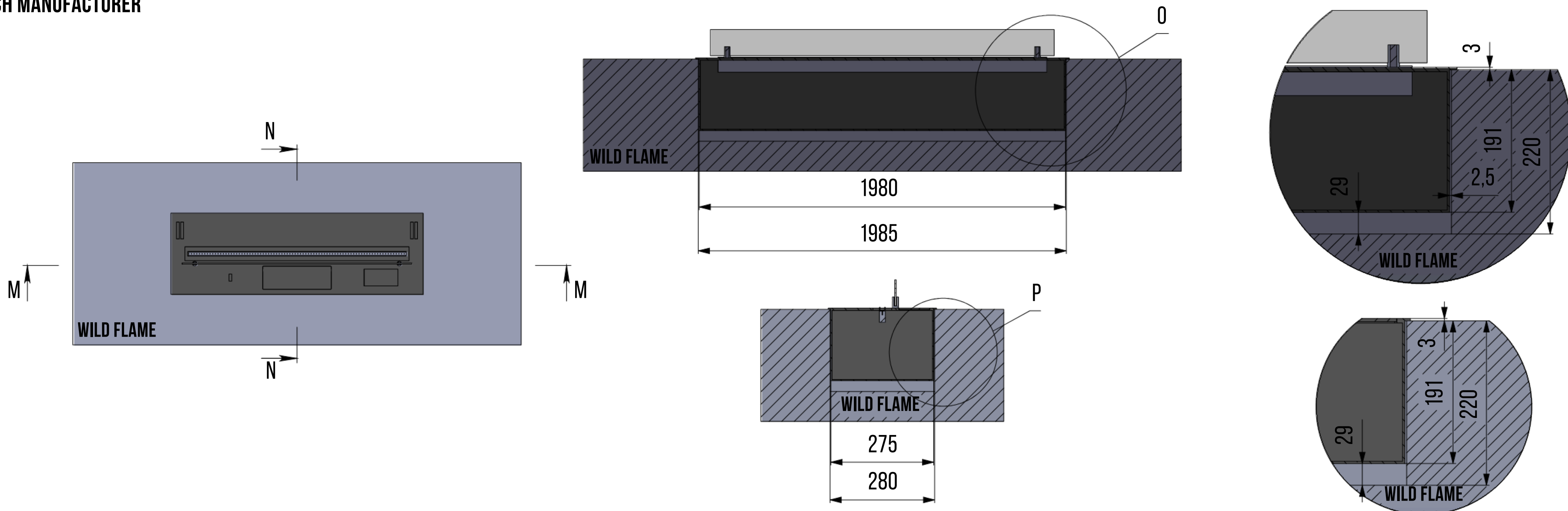

SCHEME OF INSTALLATION OF AN AUTOMATIC BIOFIREPLACE SMART FIRE A7 2000 MM IN A NICHE (FLUSH - MOUNTED)

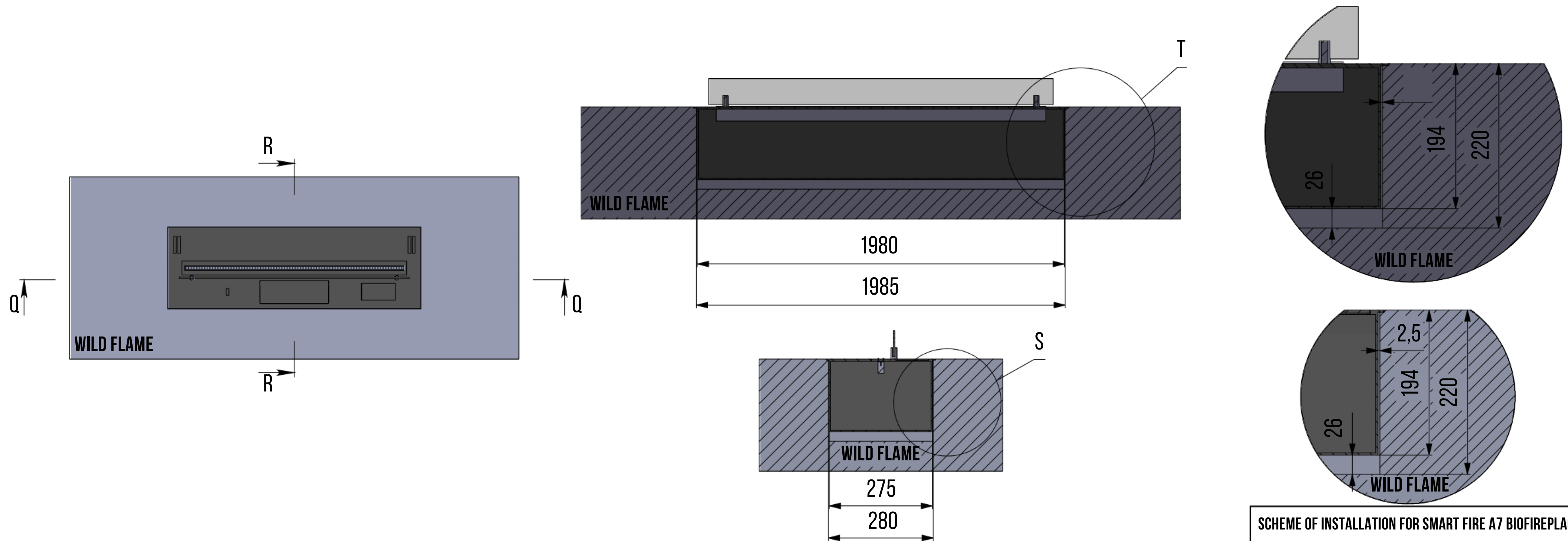

SCHEME OF INSTALLATION FOR SMART FIRE A7 BIOFIREPLACE