

WILD FLAME

DUTCH MANUFACTURER

SCHEME OF AUTOMATIC BIOFIREPLACE SMART FIRE A7 3500 MM

FRONT VIEW

SIDE VIEW

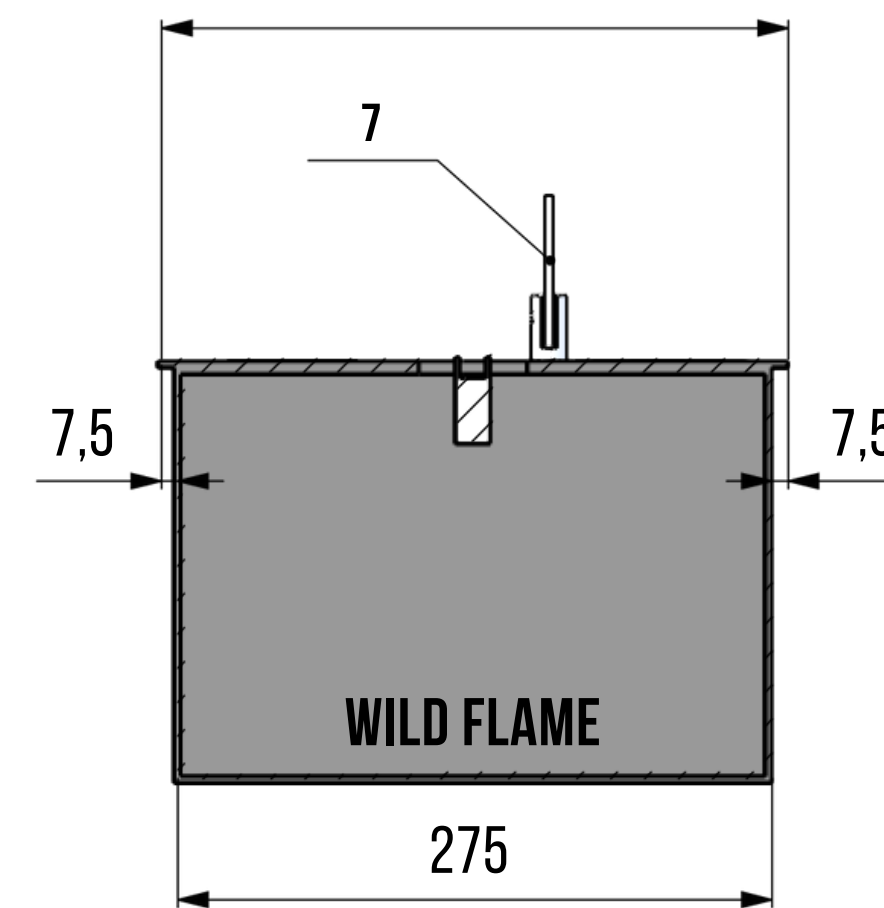
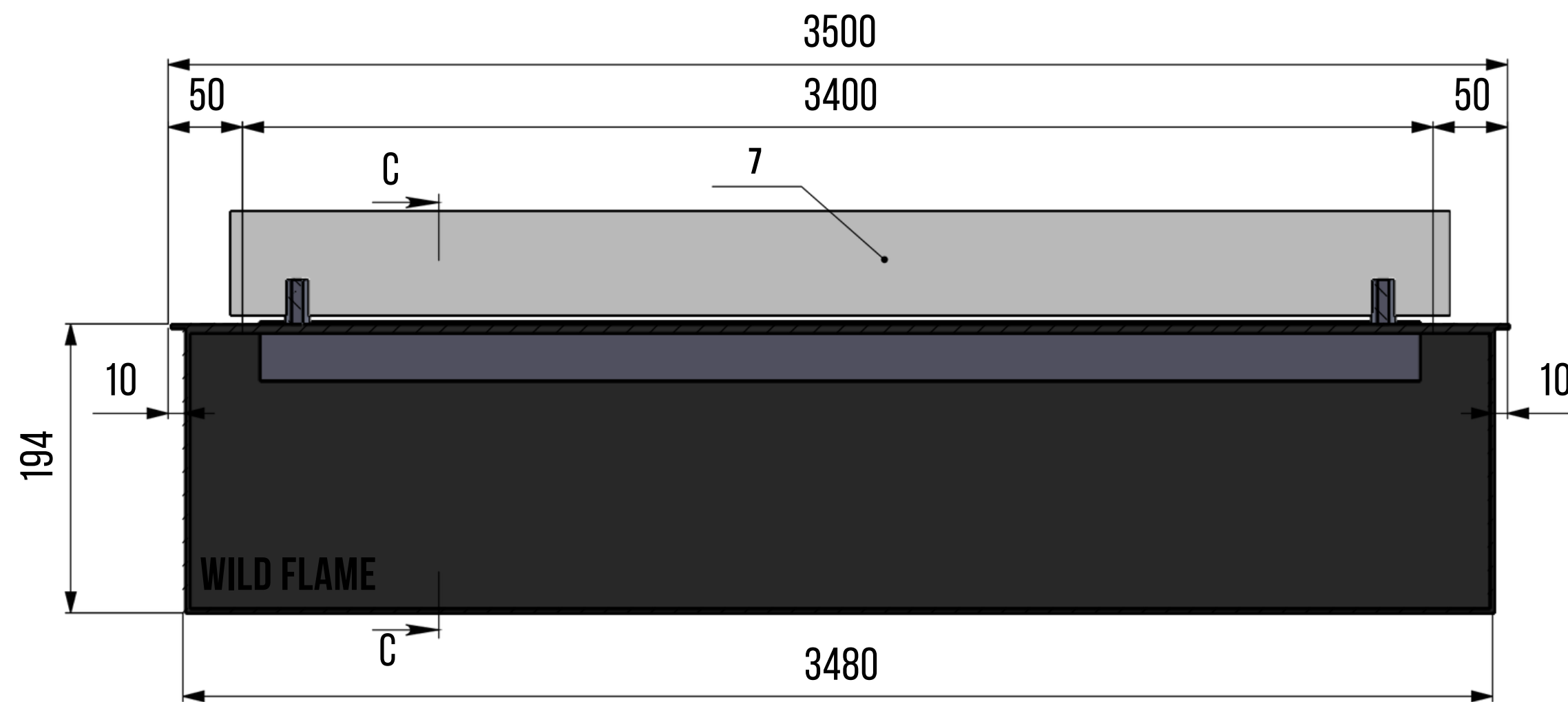

TOP VIEW

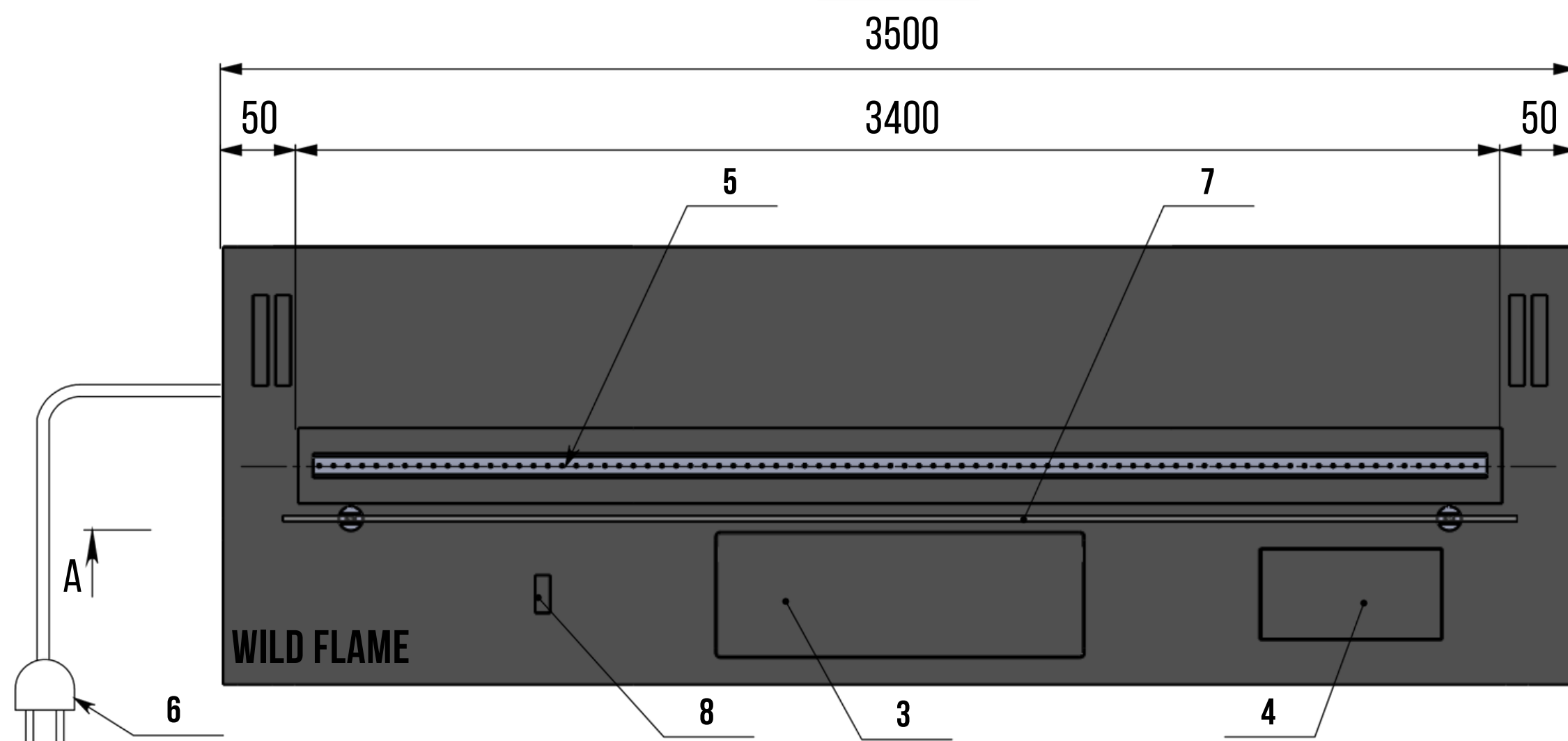

NO:	NAMES
1	FRONT PANEL OF AUTOMATIC BIOFIREPLACE
2	DOUBLE - WALL HULL
3	CONTROL PANEL COVER AND REFUELING
4	WIRELESS CHARGING SURFACE
5	FIRE LINE
6	POWER CABLE (220V)
7	TEMPERED SAFETY GLASS
8	SENSOR FOR OPENING THE COVER OF THE CONTROL PANEL AND REFUELING

COLOUR: ACCORDING TO RAL SCALE _____
WEIGHT: 105 KG.

SCHEME OF SMART FIRE A7
3500 X 290 X 194 MM
WWW.WILDFLAME.NL

WILD FLAME

DUTCH MANUFACTURER

SCHEME OF NICHE FOR AN AUTOMATIC BIOFIREPLACE SMART FIRE A7 3500 MM (OVERLAP)

FRONT VIEW

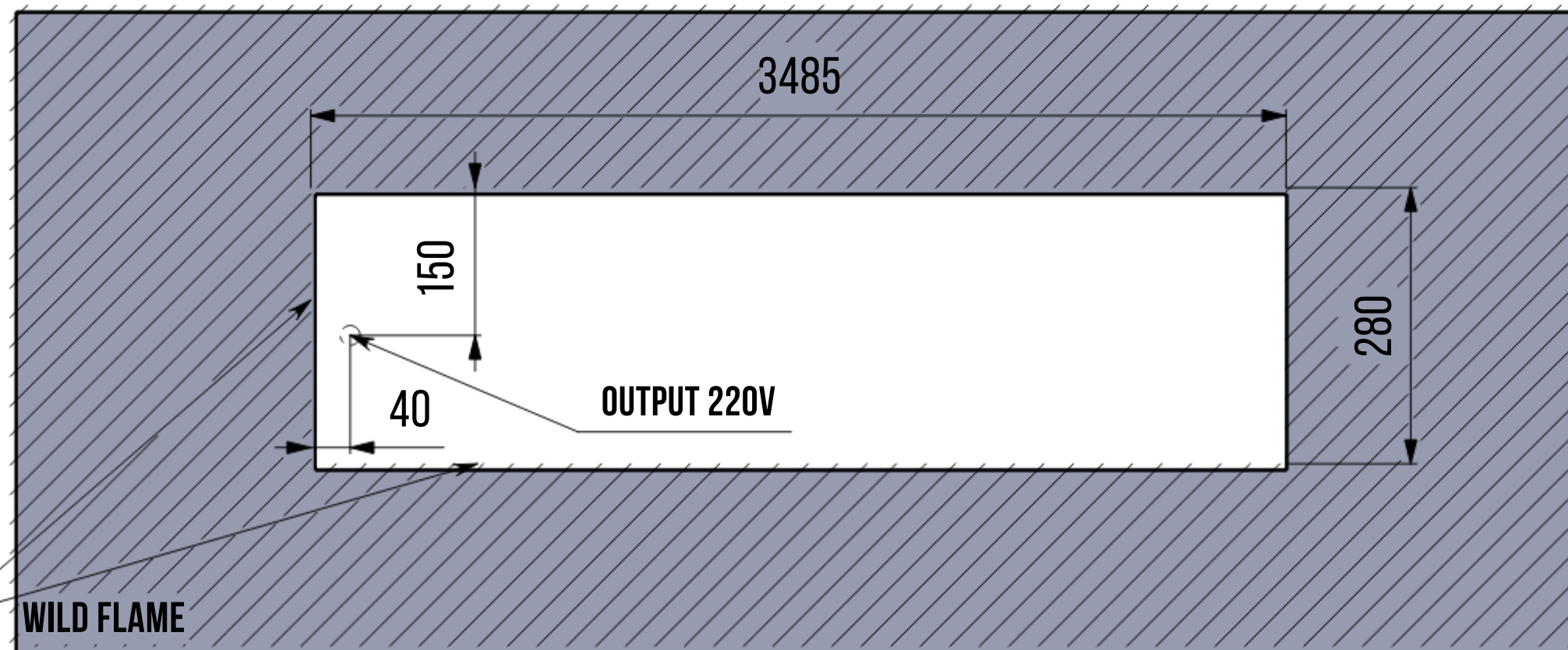

NICHE DIMENSIONS FOR EMBEDDING THE FUEL BLOCK:

NICHE LENGTH - 3485 MM

NICHE WIDTH - 280 MM

NICHE DEPTH - 220 MM



TOP VIEW

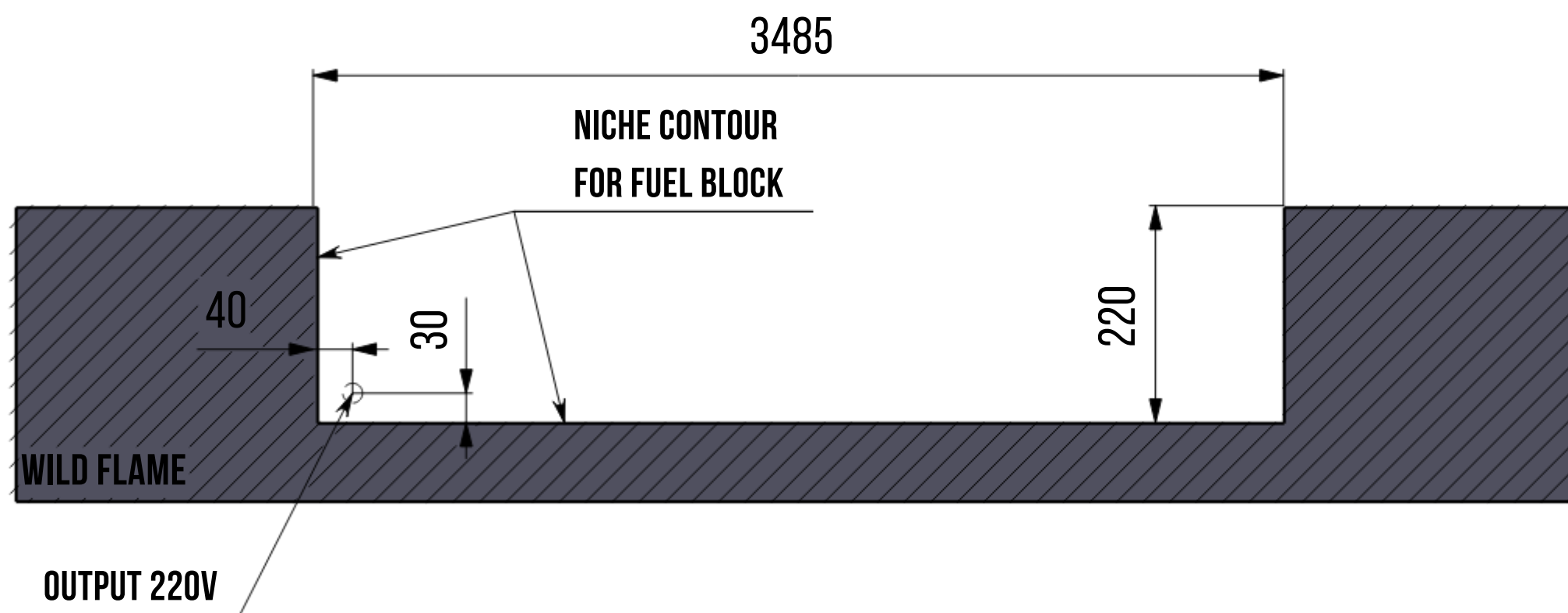

SIDE VIEW

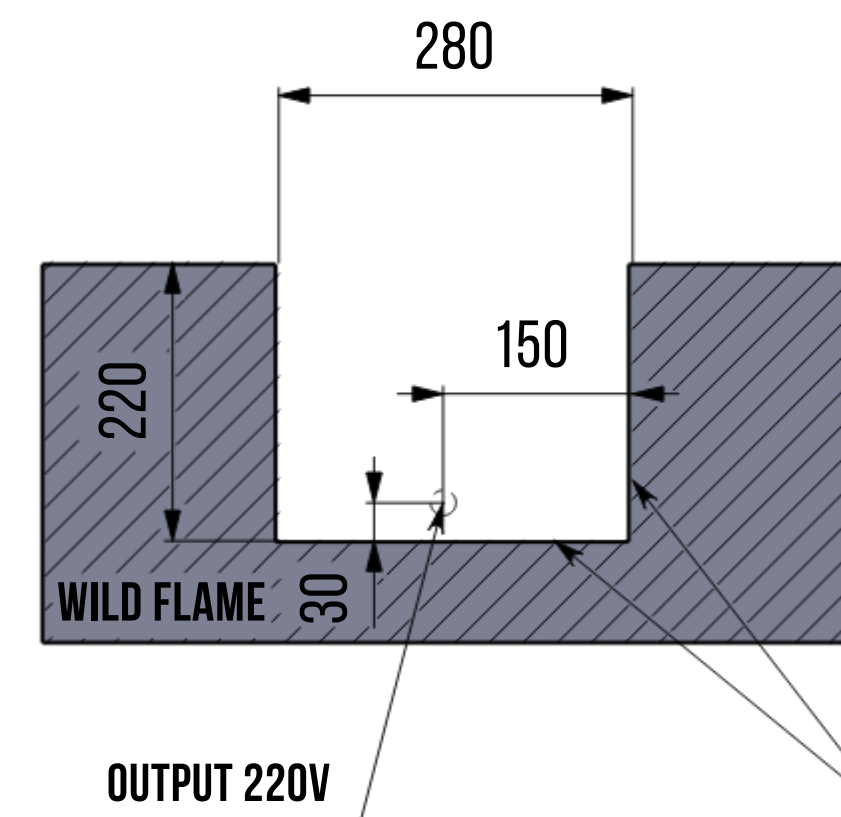

WILD FLAME

DUTCH MANUFACTURER

SCHEME OF NICHE FOR AN AUTOMATIC BIOFIREPLACE SMART FIRE A7 3500 MM (FLUSH - MOUNTED)

FRONT VIEW

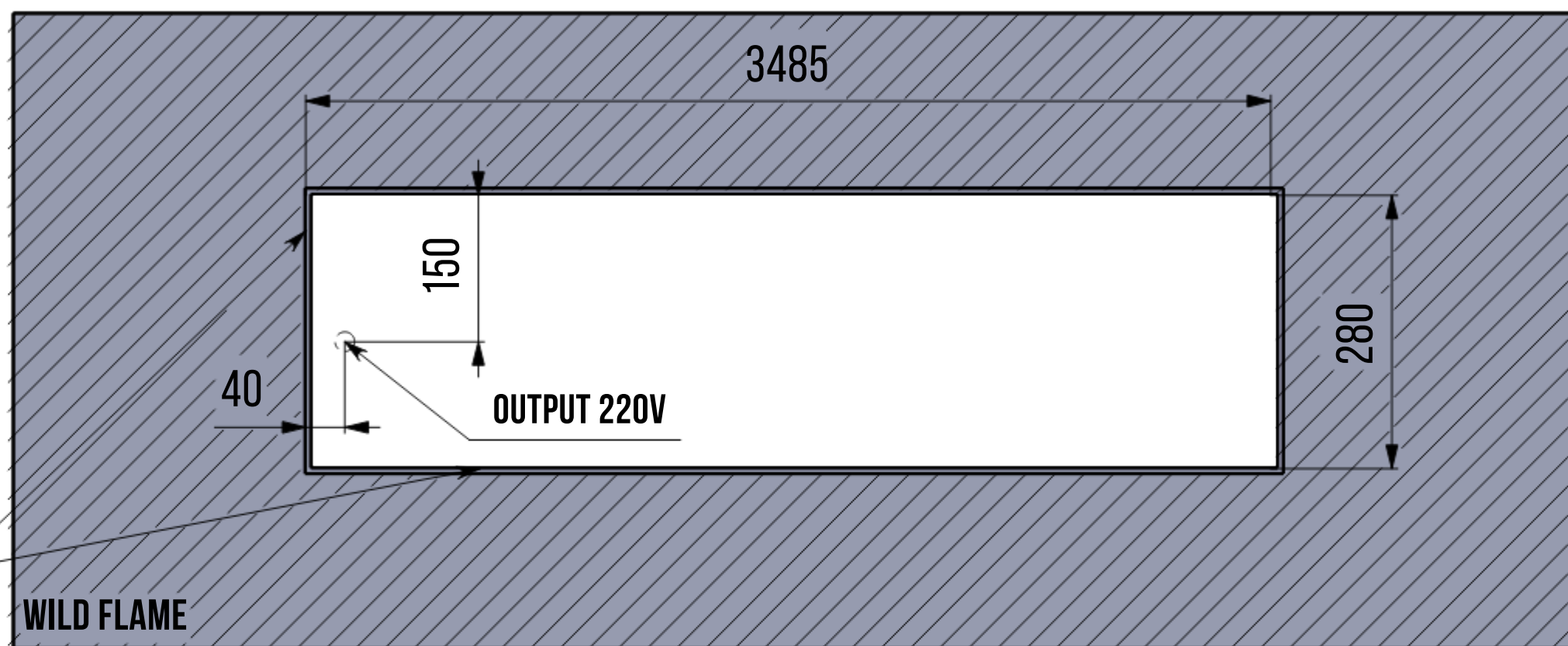

NICHE DIMENSIONS FOR EMBEDDING THE BIOFIREPLACE:

NICHE LENGTH - 3485 MM

NICHE WIDTH - 280 MM

NICHE DEPTH - 220 MM

DIMENSIONS OF THE SEAT FOR THE FRONT PANEL OF THE BIOFIREPLACE:

NICHE LENGTH - 3502 MM

NICHE WIDTH - 292 MM

NICHE DEPTH - 3 MM



**NICHE CONTOUR
FOR FUEL BLOCK**

WILD FLAME

TOP VIEW

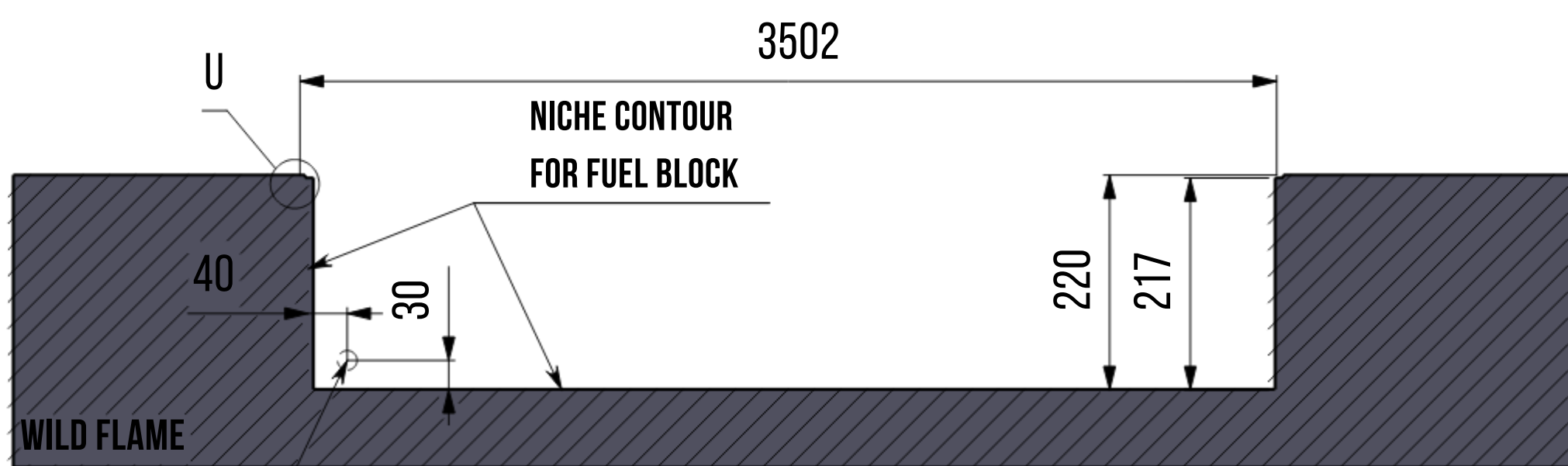

SIDE VIEW

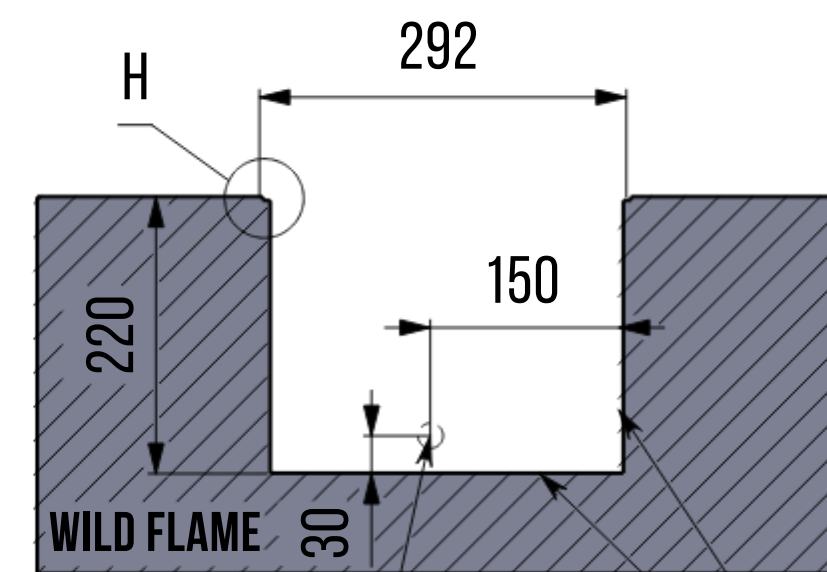

OUTPUT 220V

OUTPUT 220V

**NICHE CONTOUR
FOR FUEL BLOCK**

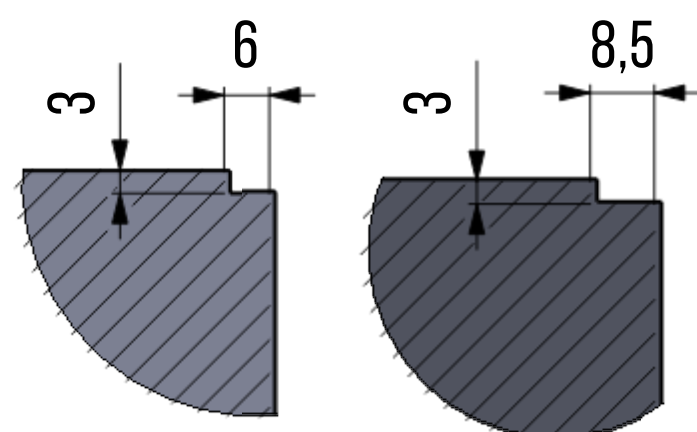

WILD FLAME

SCHEME OF INSTALLATION OF AN AUTOMATIC BIOFIREPLACE SMART FIRE A7 3500 MM IN A NICHE (OVERLAP)

DUTCH MANUFACTURER

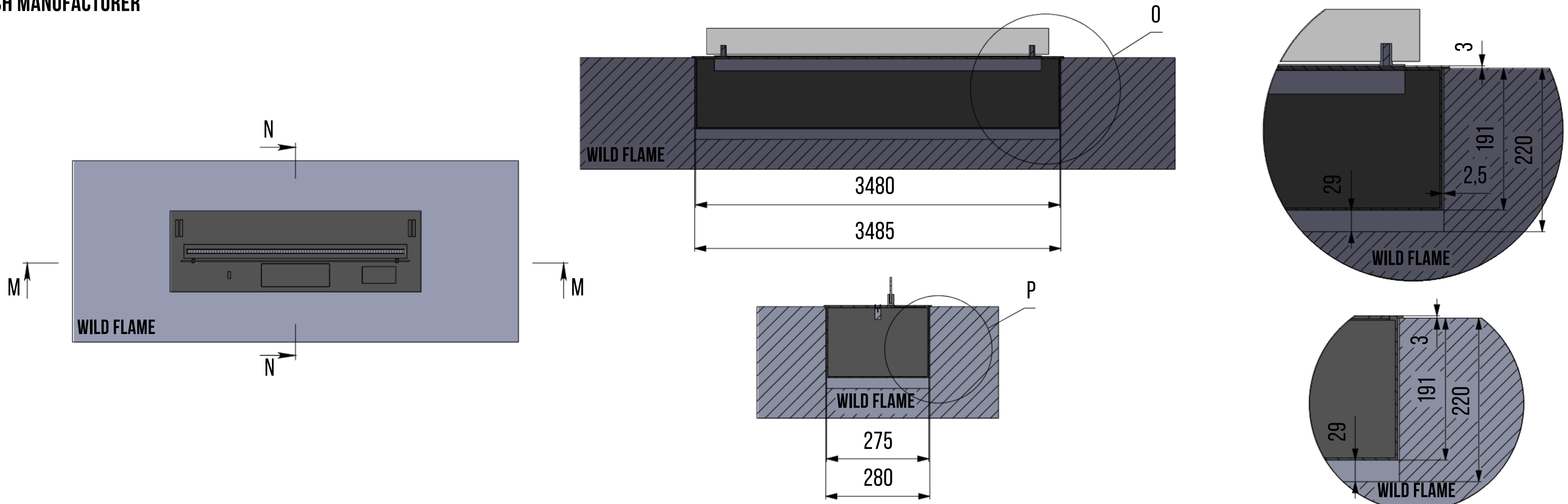

SCHEME OF INSTALLATION OF AN AUTOMATIC BIOFIREPLACE SMART FIRE A7 3500 MM IN A NICHE (FLUSH - MOUNTED)

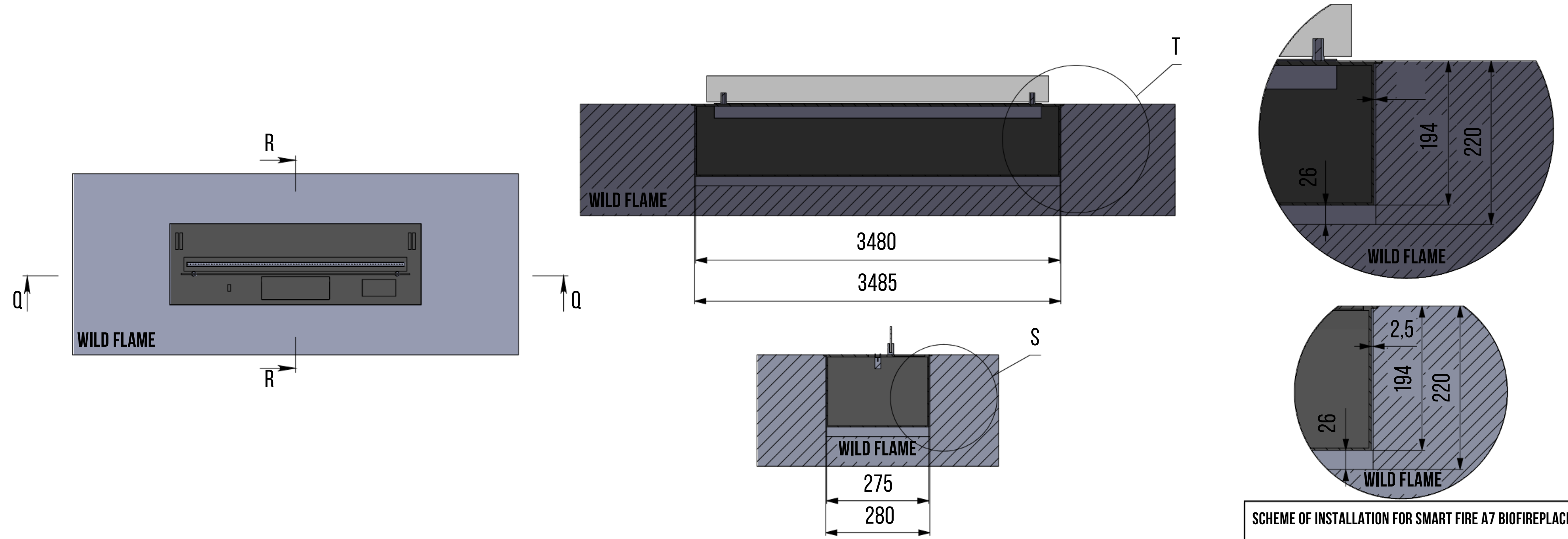

SCHEME OF INSTALLATION FOR SMART FIRE A7 BIOFIREPLACE