

**WILD FLAME**

DUTCH MANUFACTURER

**SCHEME OF AUTOMATIC BIOFIREPLACE SMART FIRE A7 4300 MM**

**FRONT VIEW**

**SIDE VIEW**

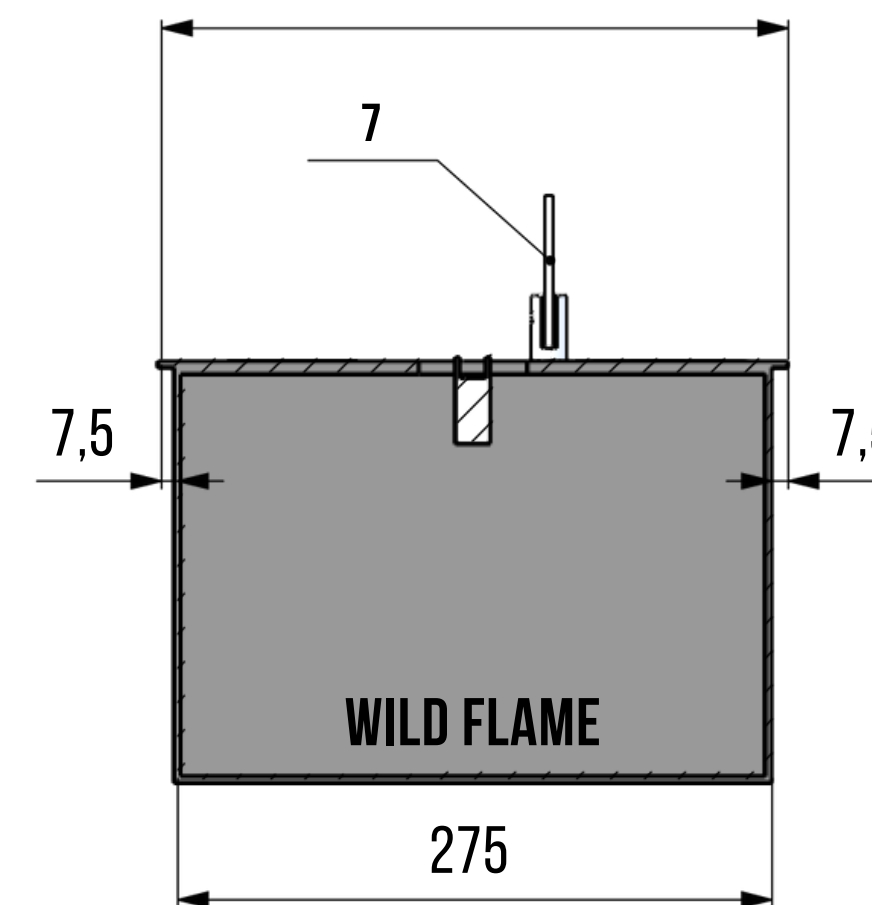
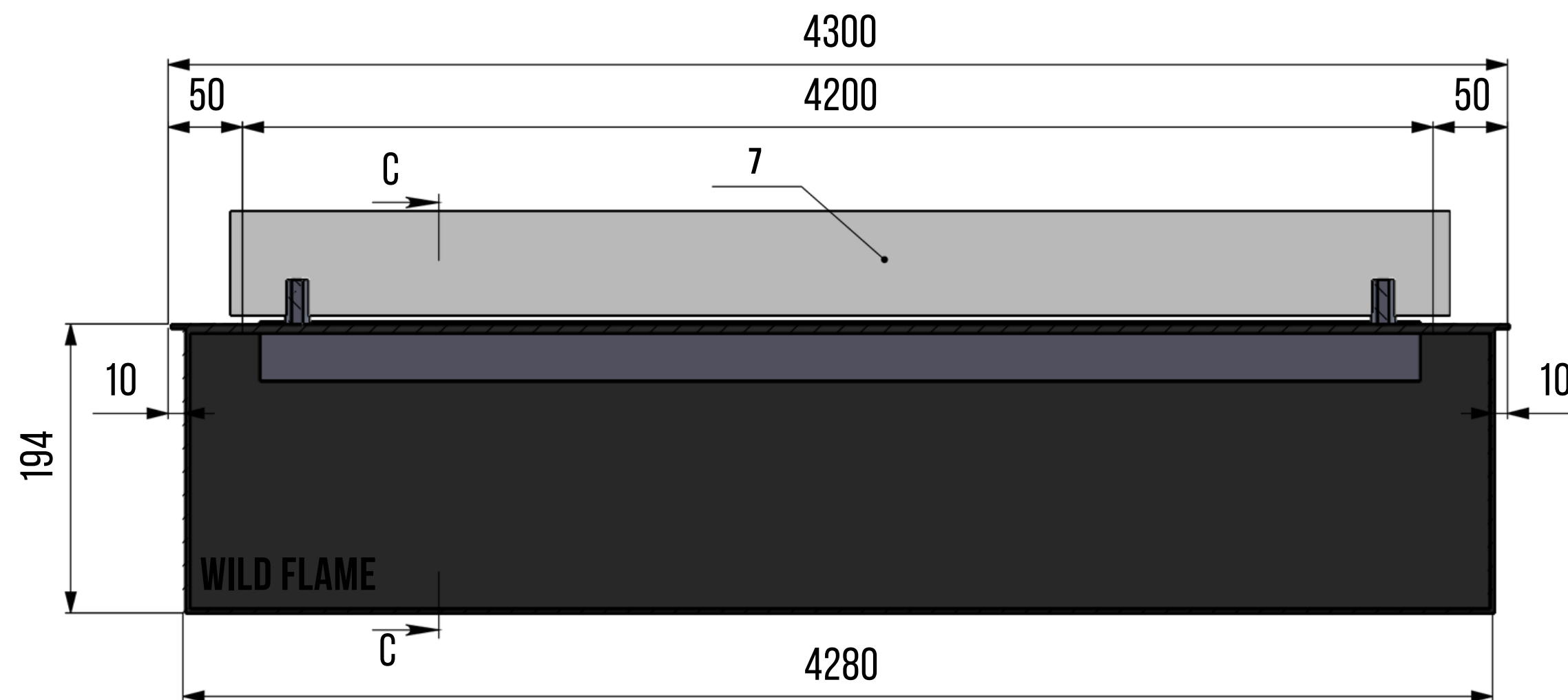

**TOP VIEW**

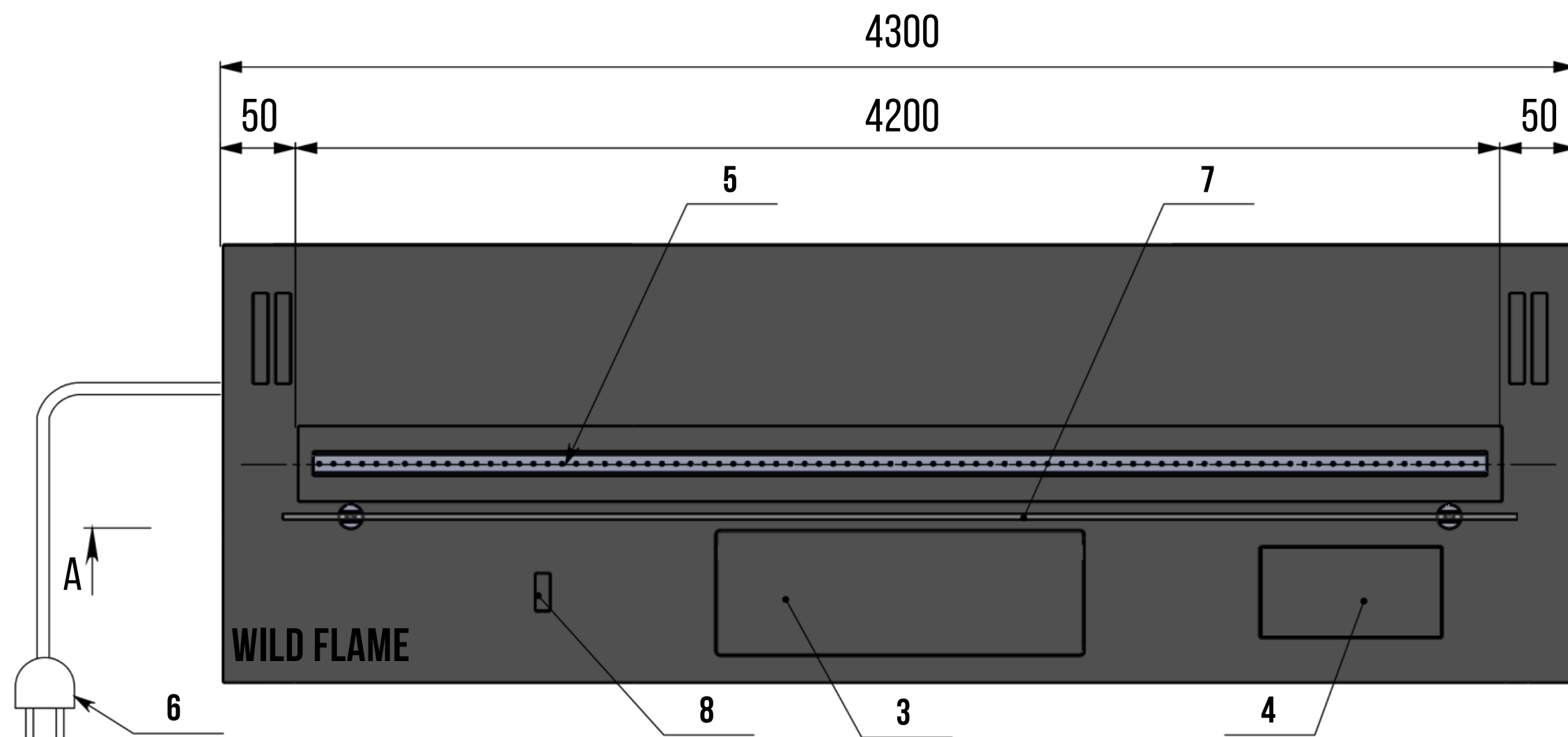

NO:	NAMES
1	FRONT PANEL OF AUTOMATIC BIOFIREPLACE
2	DOUBLE - WALL HULL
3	CONTROL PANEL COVER AND REFUELING
4	WIRELESS CHARGING SURFACE
5	FIRE LINE
6	POWER CABLE ( 220V )
7	TEMPERED SAFETY GLASS
8	SENSOR FOR OPENING THE COVER OF THE CONTROL PANEL AND REFUELING

COLOUR: ACCORDING TO RAL SCALE \_\_\_\_\_  
WEIGHT: 130 KG.

<b>SCHEME OF SMART FIRE A7</b>
<b>4300 X 290 X 194 MM</b>
<b>WWW.WILDFLAME.NL</b>

**WILD FLAME**

**DUTCH MANUFACTURER**

# SCHEME OF NICHE FOR AN AUTOMATIC BIOFIREPLACE SMART FIRE A7 4300 MM ( OVERLAP )

**FRONT VIEW**

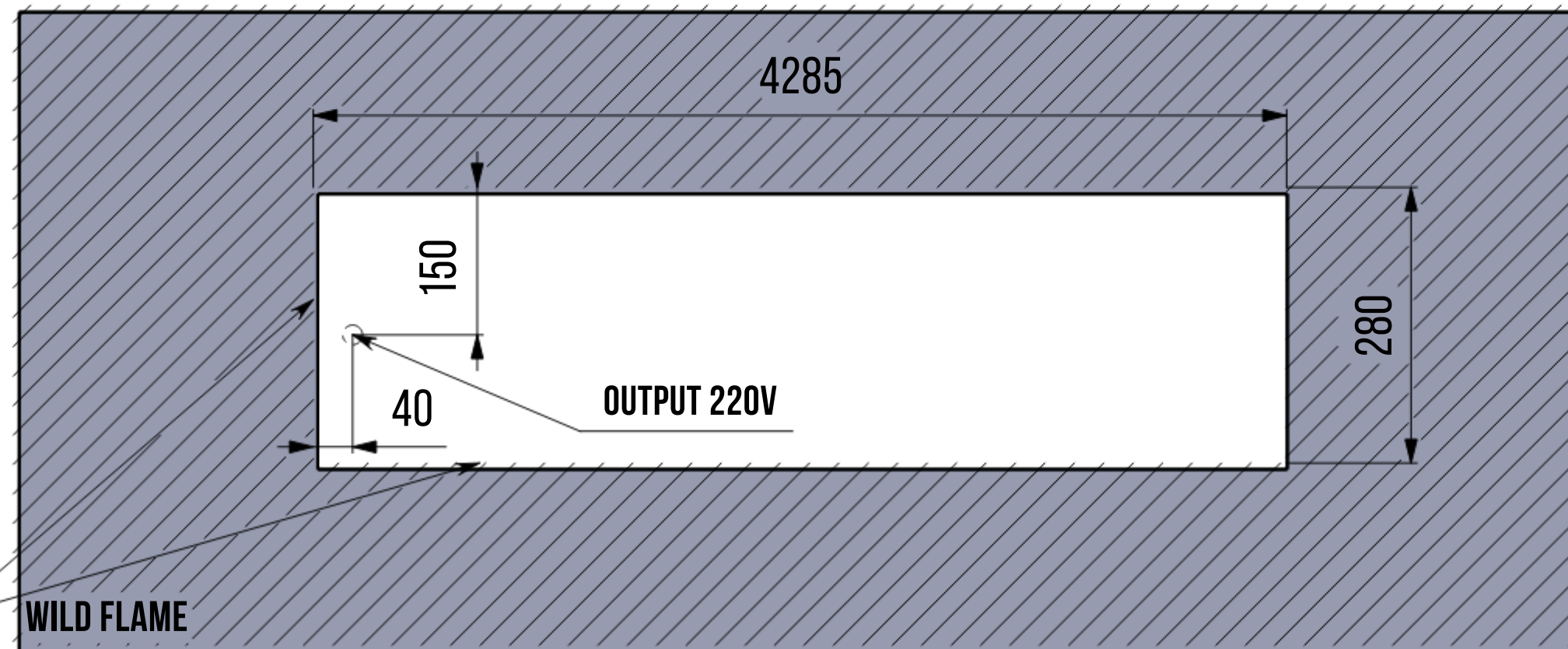

**NICHE DIMENSIONS FOR EMBEDDING THE FUEL BLOCK:**

NICHE LENGTH - 4285 MM

NICHE WIDTH - 280 MM

NICHE DEPTH - 220 MM



**TOP VIEW**

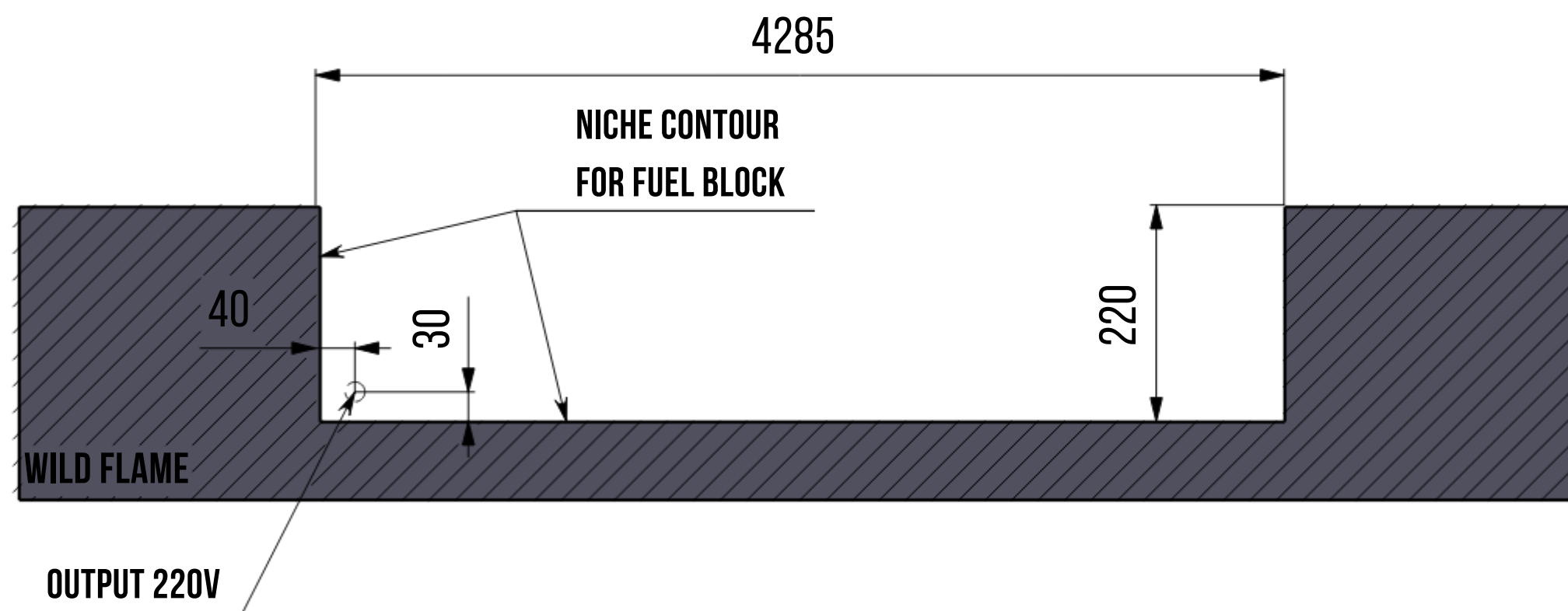

**SIDE VIEW**

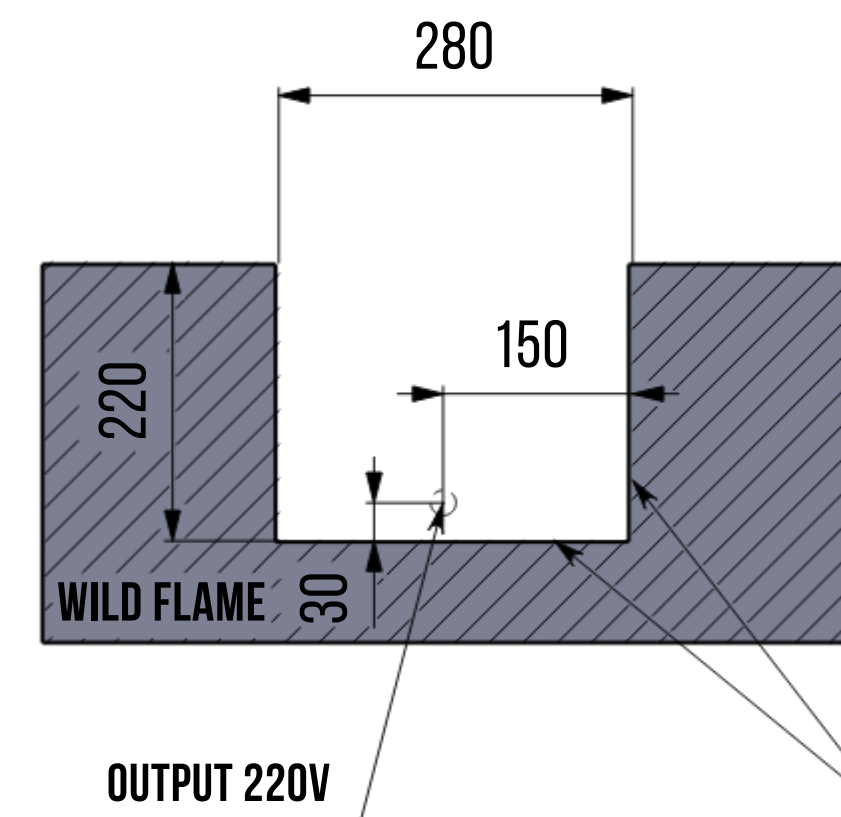

**WILD FLAME**

**DUTCH MANUFACTURER**

# SCHEME OF NICHE FOR AN AUTOMATIC BIOFIREPLACE SMART FIRE A7 4300 MM ( FLUSH - MOUNTED )

**FRONT VIEW**

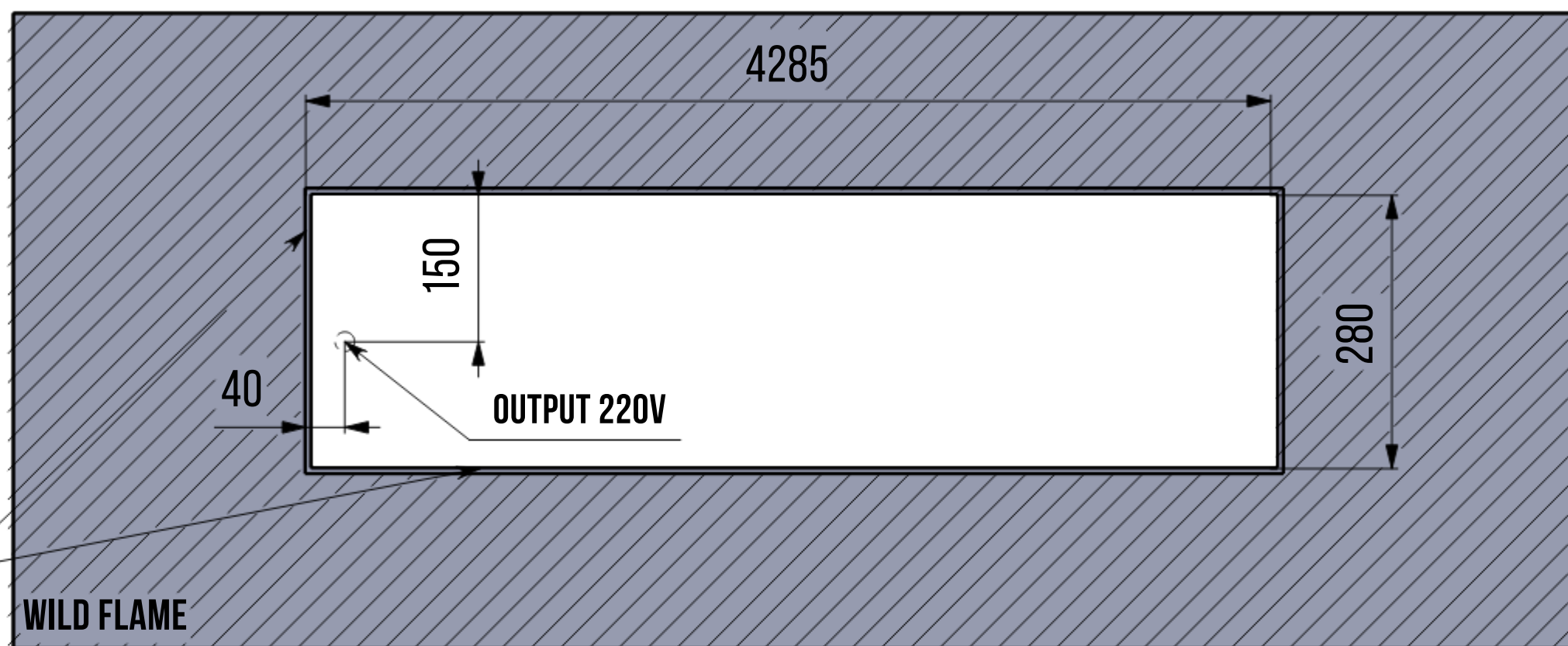

**NICHE DIMENSIONS FOR EMBEDDING THE BIOFIREPLACE:**

NICHE LENGTH - 4285 MM

NICHE WIDTH - 280 MM

NICHE DEPTH - 220 MM

**DIMENSIONS OF THE SEAT FOR THE FRONT PANEL OF THE BIOFIREPLACE:**

NICHE LENGTH - 4302 MM

NICHE WIDTH - 292 MM

NICHE DEPTH - 3 MM



**NICHE CONTOUR  
FOR FUEL BLOCK**

**WILD FLAME**

**TOP VIEW**

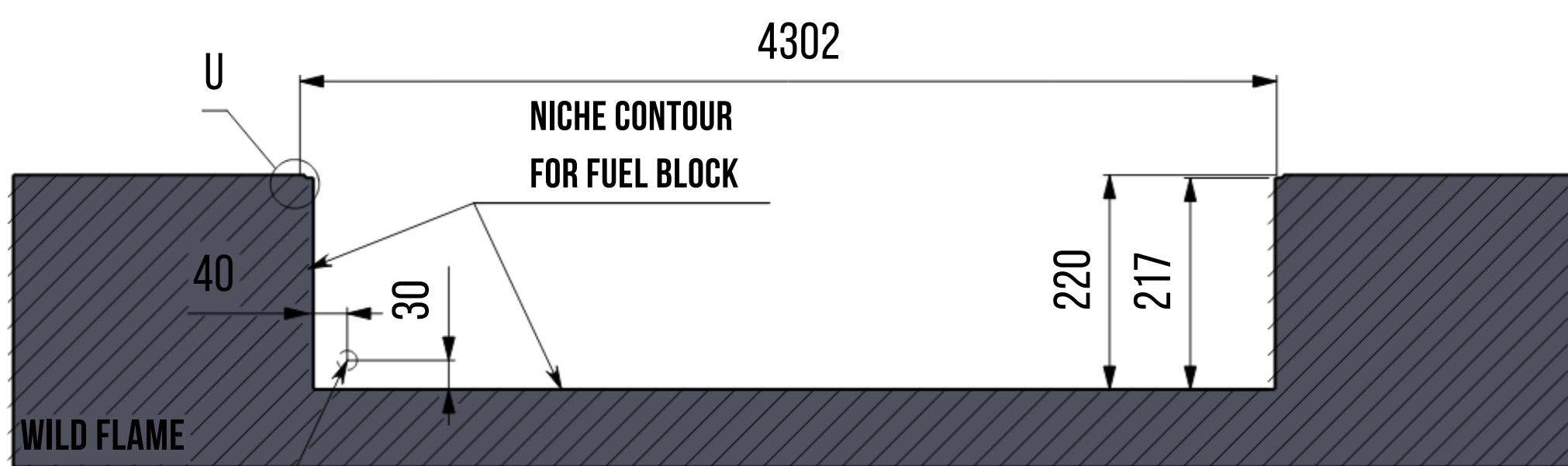

**OUTPUT 220V**

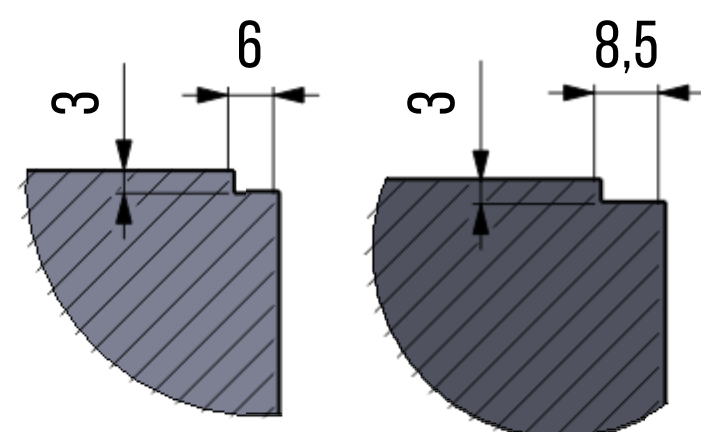

**SIDE VIEW**

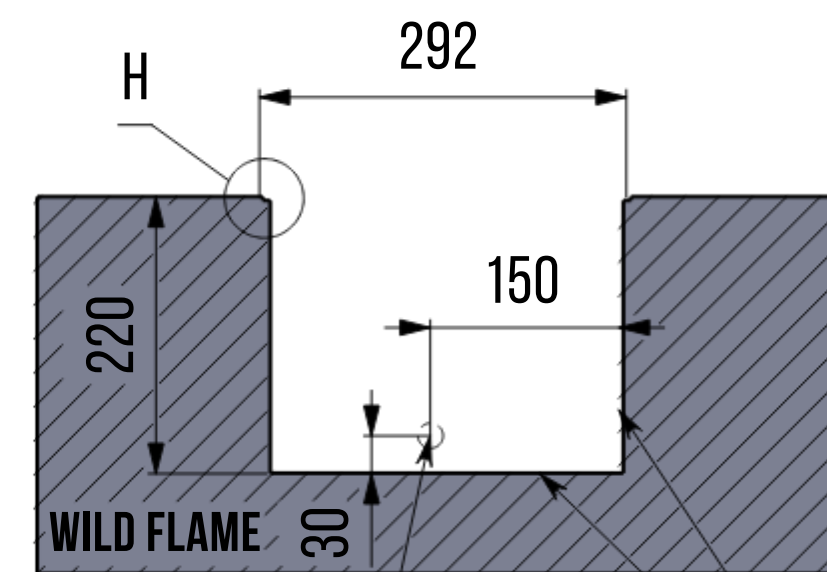

**OUTPUT 220V**

**NICHE CONTOUR  
FOR FUEL BLOCK**

**WILD FLAME**

# SCHEME OF INSTALLATION OF AN AUTOMATIC BIOFIREPLACE SMART FIRE A7 4300 MM IN A NICHE ( OVERLAP )

DUTCH MANUFACTURER

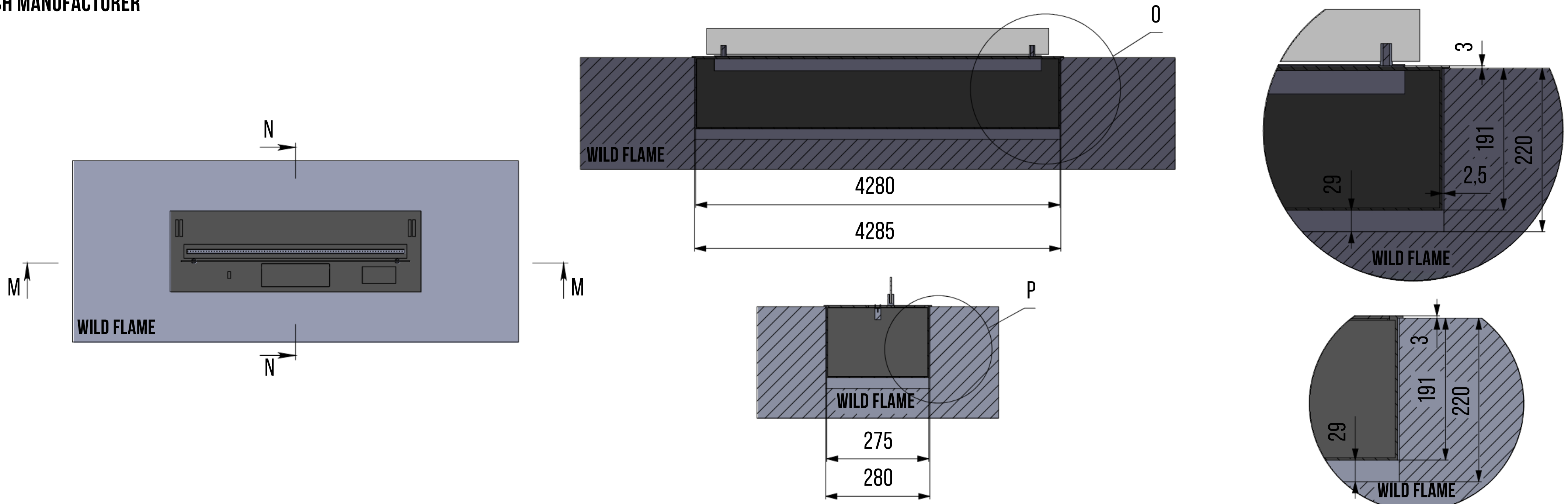

# SCHEME OF INSTALLATION OF AN AUTOMATIC BIOFIREPLACE SMART FIRE A7 4300 MM IN A NICHE ( FLUSH - MOUNTED )

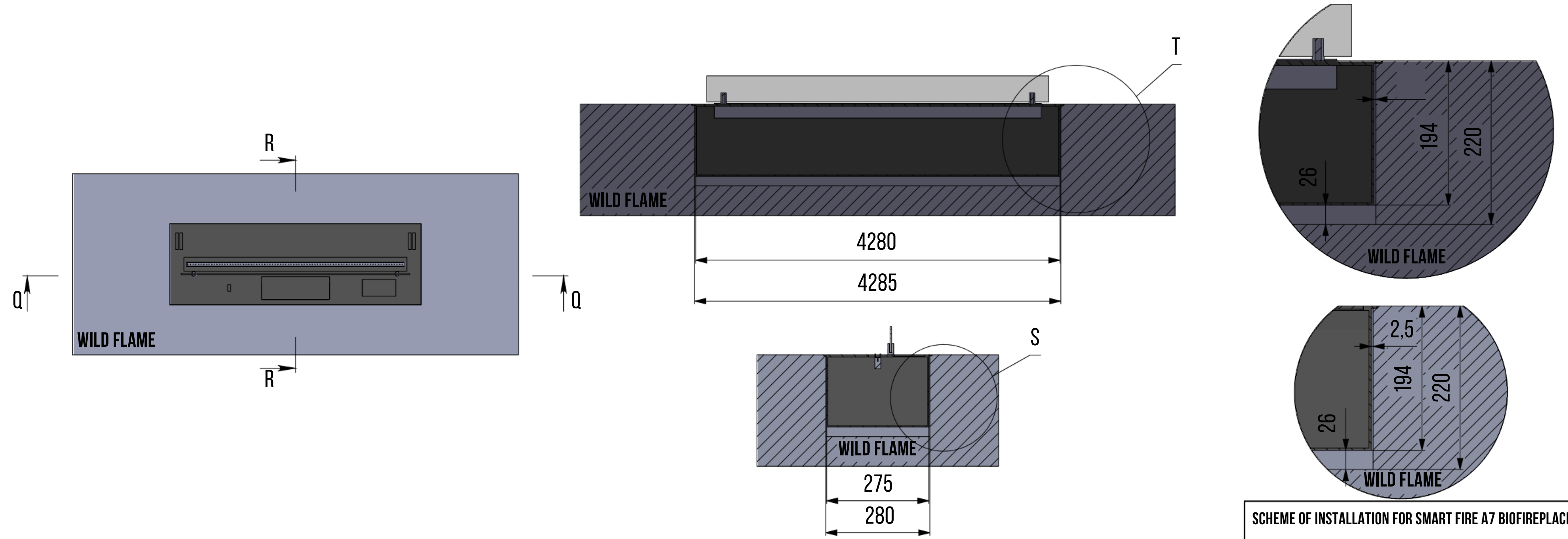

SCHEME OF INSTALLATION FOR SMART FIRE A7 BIOFIREPLACE