

WILD FLAME

DUTCH MANUFACTURER

SCHEME OF AUTOMATIC BIOFIREPLACE SMART FIRE A7 4600 MM

FRONT VIEW

SIDE VIEW

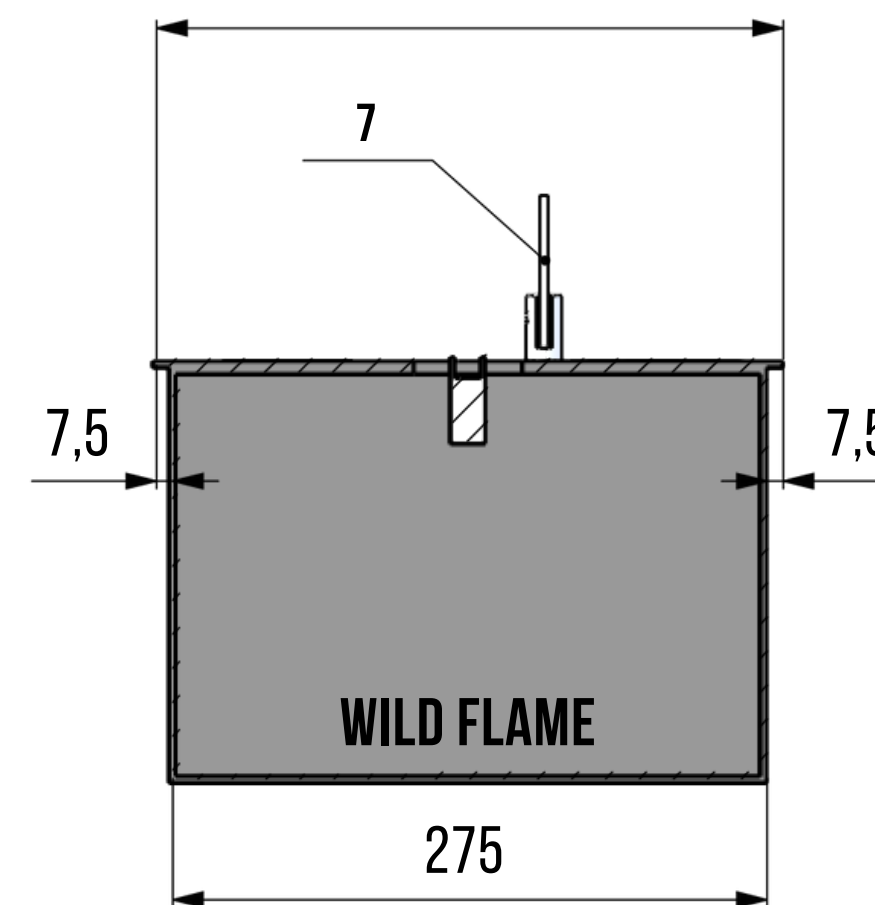
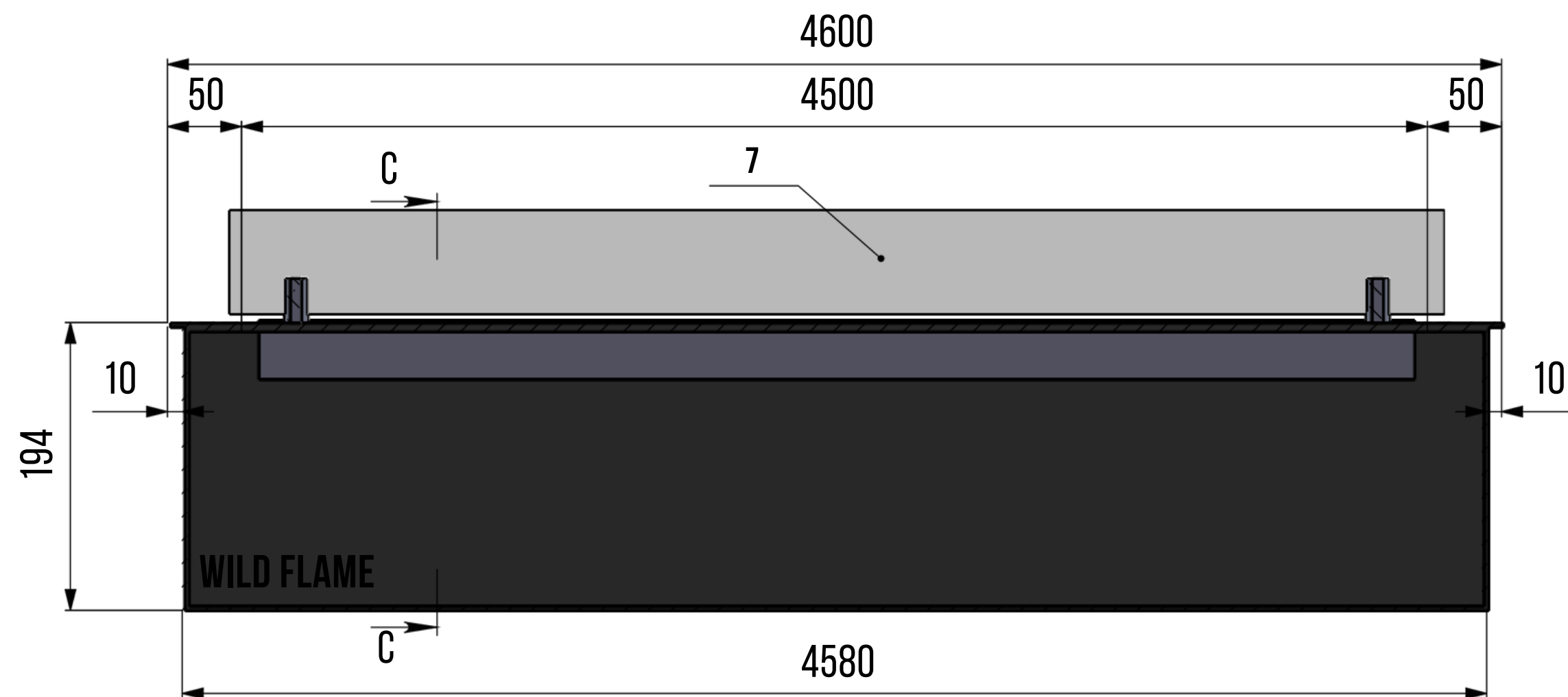

TOP VIEW

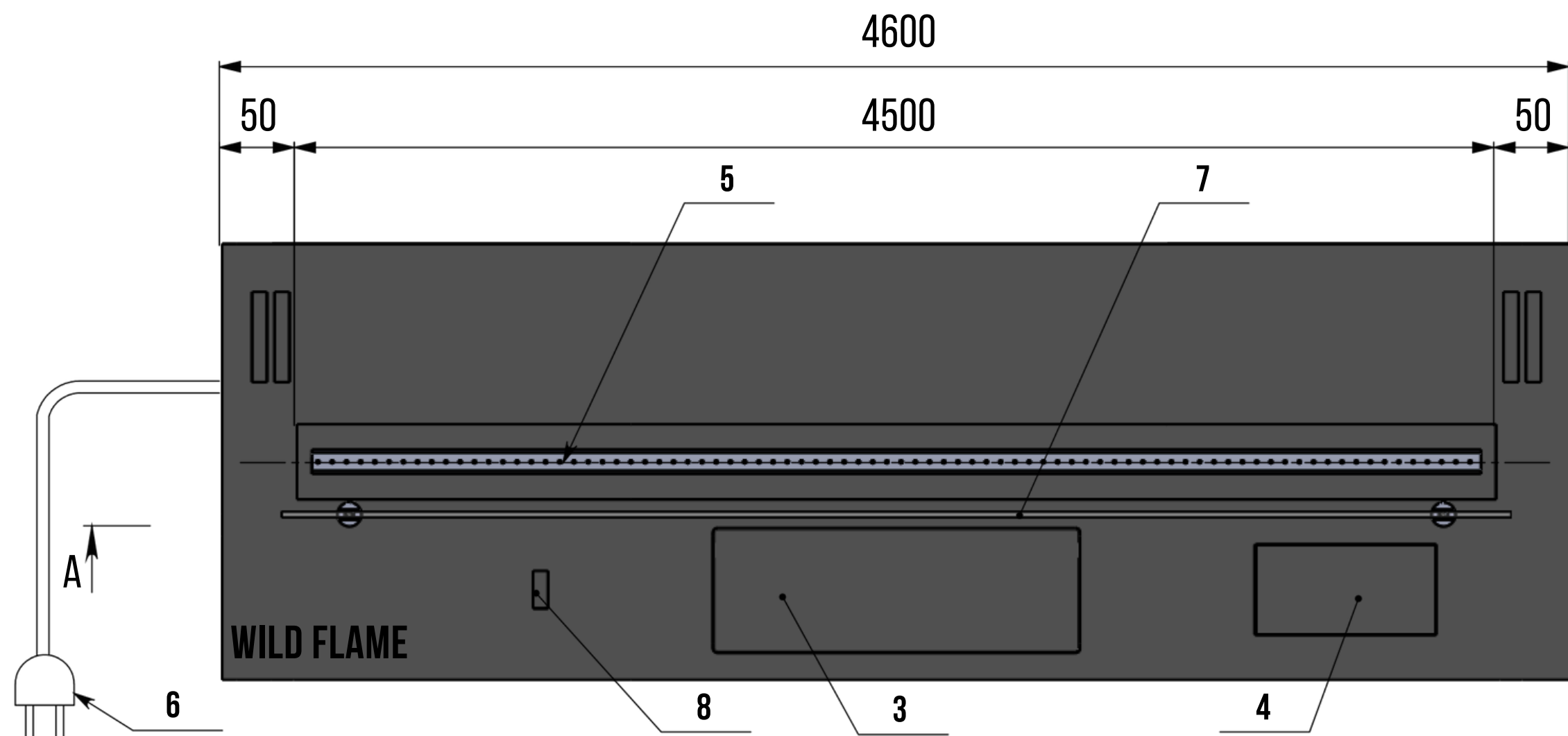

NO:	NAMES
1	FRONT PANEL OF AUTOMATIC BIOFIREPLACE
2	DOUBLE - WALL HULL
3	CONTROL PANEL COVER AND REFUELING
4	WIRELESS CHARGING SURFACE
5	FIRE LINE
6	POWER CABLE (220V)
7	TEMPERED SAFETY GLASS
8	SENSOR FOR OPENING THE COVER OF THE CONTROL PANEL AND REFUELING

COLOUR: ACCORDING TO RAL SCALE _____
WEIGHT: 140 KG.

SCHEME OF SMART FIRE A7

4600 X 290 X 194 MM

WWW.WILDFLAME.NL

WILD FLAME

DUTCH MANUFACTURER

SCHEME OF NICHE FOR AN AUTOMATIC BIOFIREPLACE SMART FIRE A7 4600 MM (OVERLAP)

FRONT VIEW

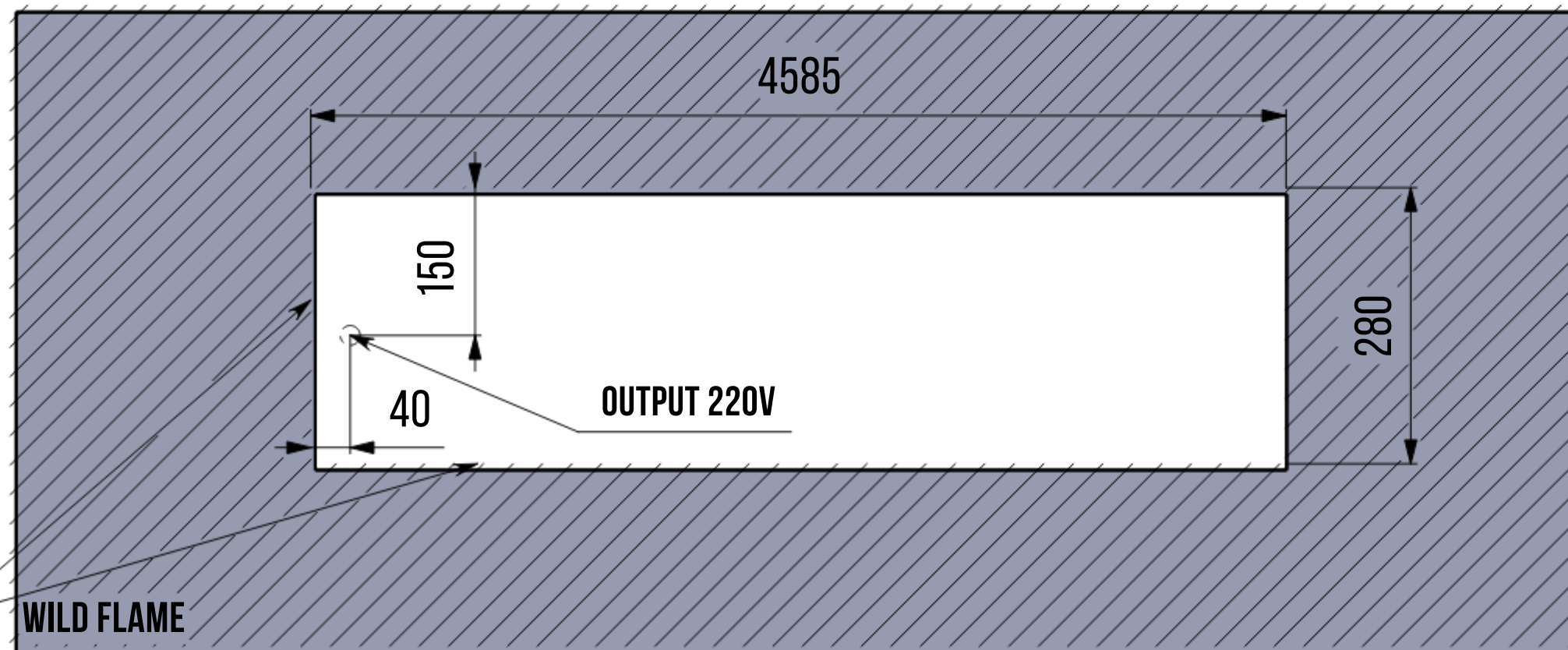

NICHE DIMENSIONS FOR EMBEDDING THE FUEL BLOCK:

NICHE LENGTH - 4585 MM

NICHE WIDTH - 280 MM

NICHE DEPTH - 220 MM



TOP VIEW

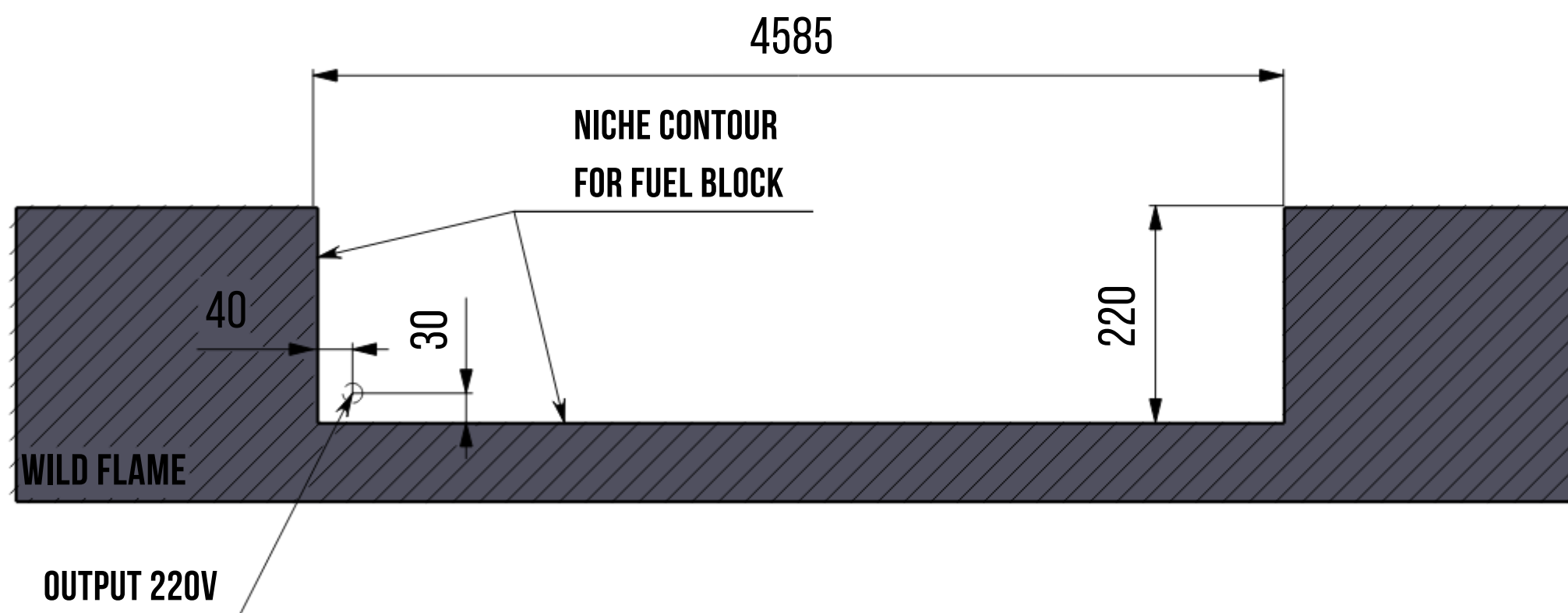

SIDE VIEW

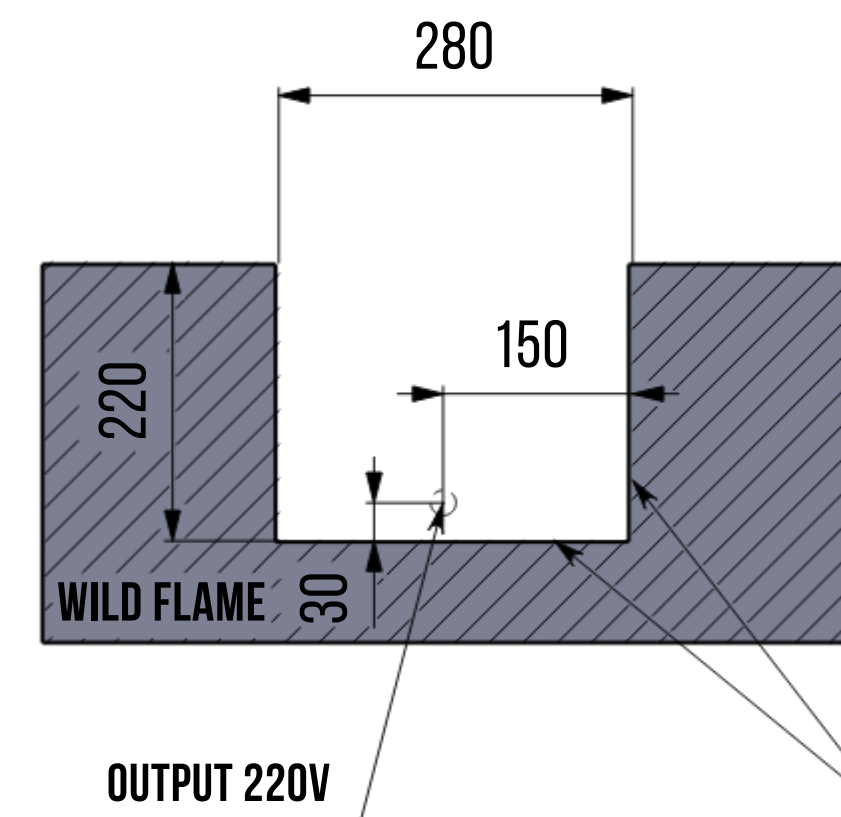

WILD FLAME

DUTCH MANUFACTURER

SCHEME OF NICHE FOR AN AUTOMATIC BIOFIREPLACE SMART FIRE A7 4600 MM (FLUSH - MOUNTED)

FRONT VIEW

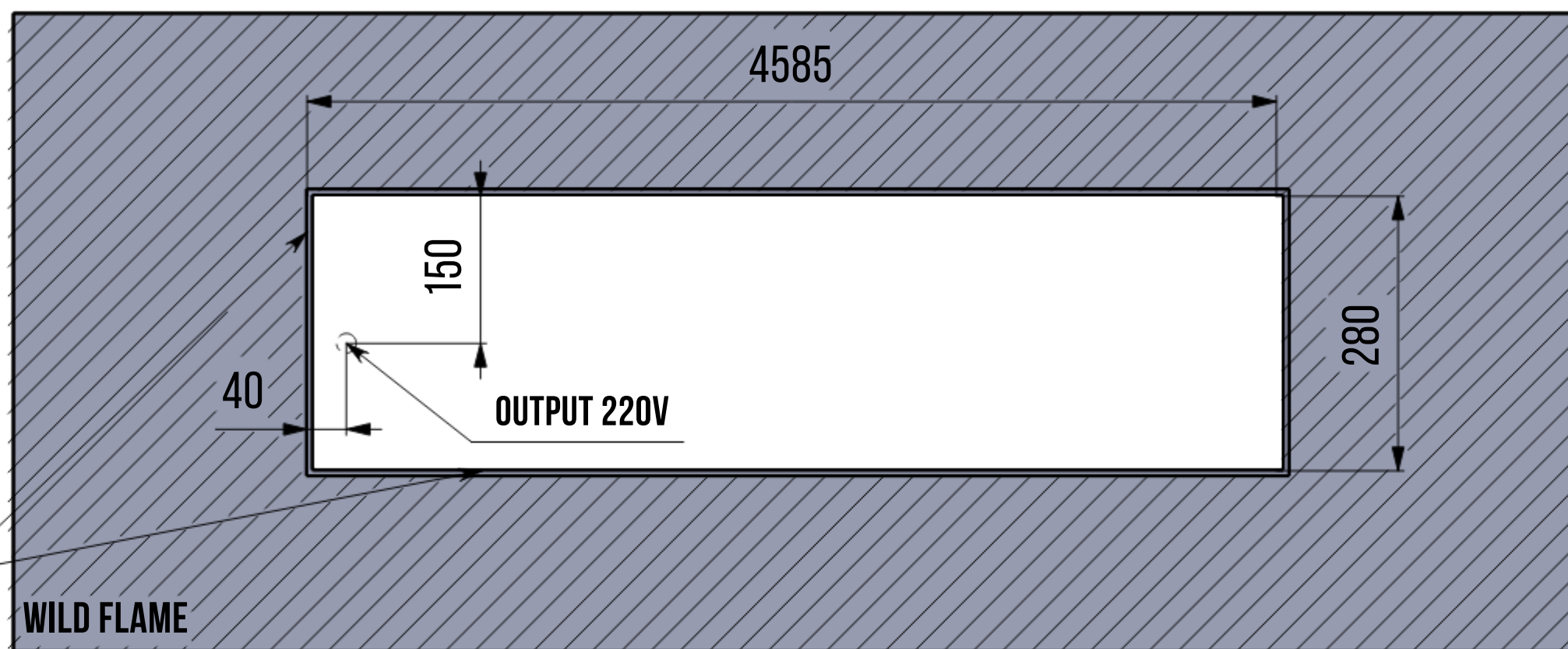

NICHE DIMENSIONS FOR EMBEDDING THE BIOFIREPLACE:

NICHE LENGTH - 4585 MM

NICHE WIDTH - 280 MM

NICHE DEPTH - 220 MM

DIMENSIONS OF THE SEAT FOR THE FRONT PANEL OF THE BIOFIREPLACE:

NICHE LENGTH - 4602 MM

NICHE WIDTH - 292 MM

NICHE DEPTH - 3 MM

TOP VIEW

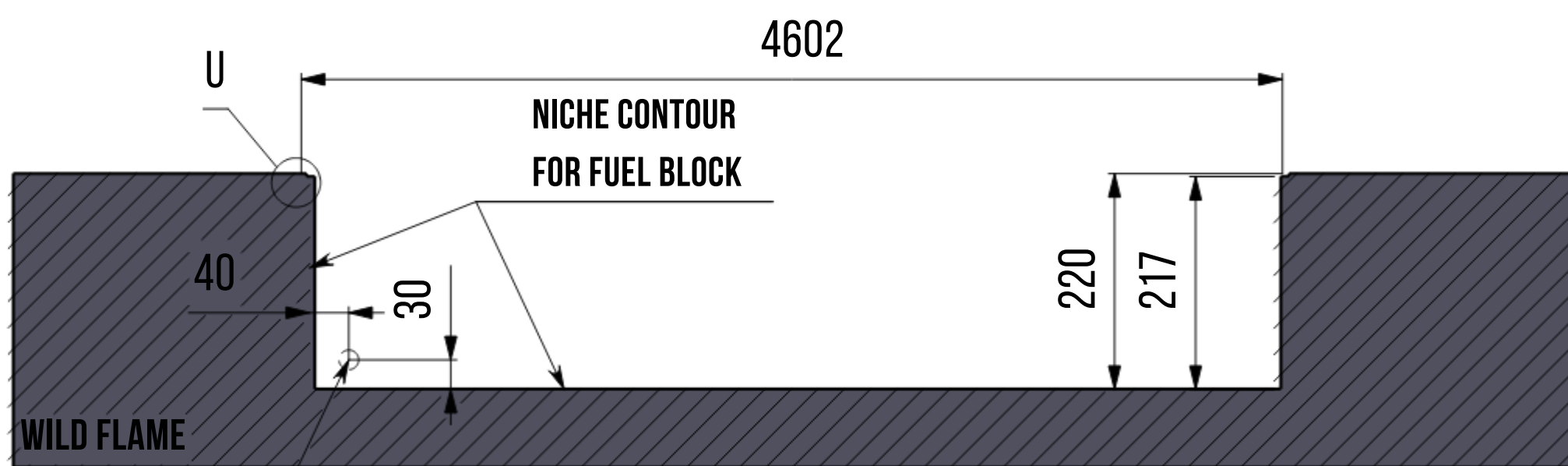
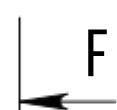

SIDE VIEW

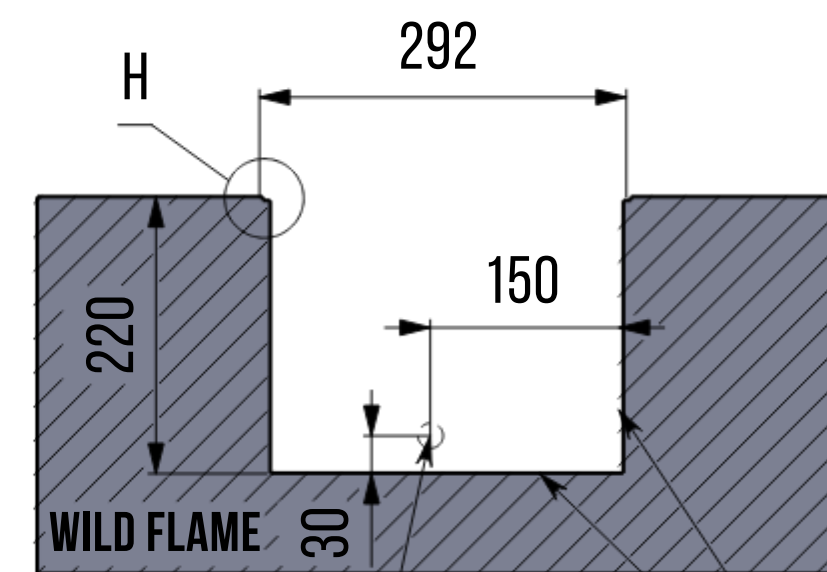
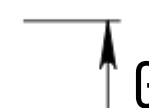

OUTPUT 220V

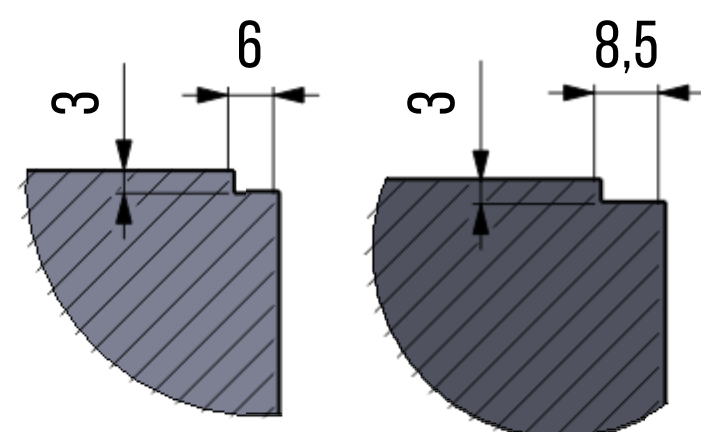

WILD FLAME

SCHEME OF INSTALLATION OF AN AUTOMATIC BIOFIREPLACE SMART FIRE A7 4600 MM IN A NICHE (OVERLAP)

DUTCH MANUFACTURER

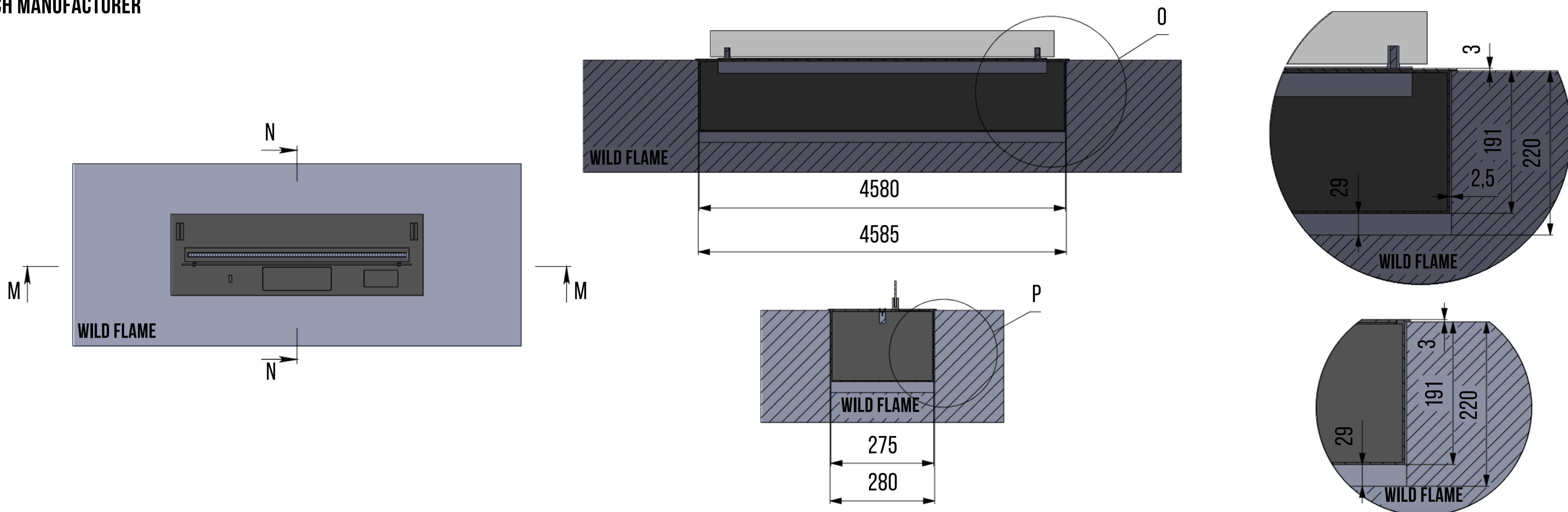

SCHEME OF INSTALLATION OF AN AUTOMATIC BIOFIREPLACE SMART FIRE A7 4600 MM IN A NICHE (FLUSH - MOUNTED)

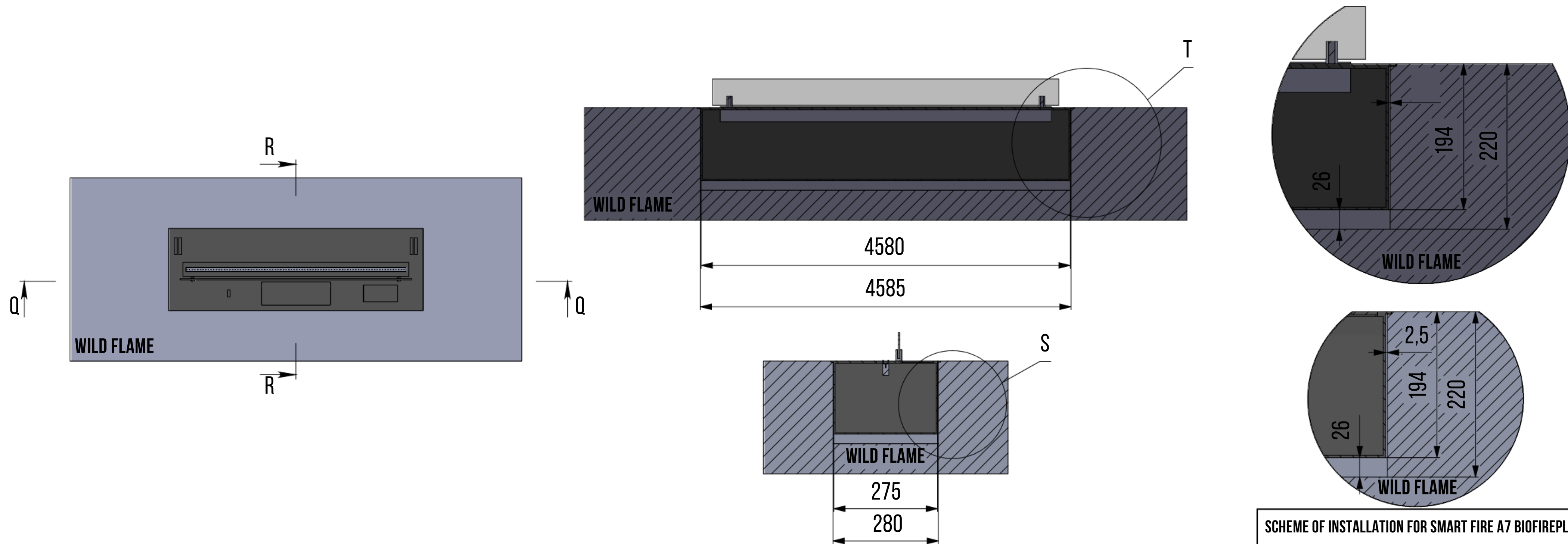

SCHEME OF INSTALLATION FOR SMART FIRE A7 BIOFIREPLACE